



THE



No.

HEALTHCARE CLEANING DIRECTORY

Together — We Make Life Better.

ninegrp.com



Your go-to guide for every product you can access on *NHS* Supply Chain

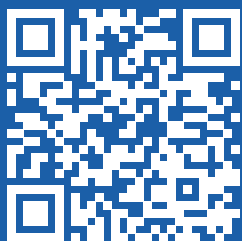

w: [ninegrp.com/nhs-supply-chain](https://www.ninegrp.com/nhs-supply-chain)

Contents

1.	Trolleys 17 >	2.	Mopping 33 >	3.	Buckets 75 >	4.	Chemicals 87 >
5.	Paper Products 105 >	6.	Medi9 113 >	7.	Washroom 127 >	8.	Cloths 139 >
9.	Wipes 151 >	10.	Brushware / Floorcare 155 >	11.	Dusting 171 >	12.	Glass Cleaning 181 >
13.	Spill Control 187 >	14.	Gloves / PPE 197 >	15.	Bins 201 >	16.	Vehicle 213 >
17.	Accessories 219 >						

DISCLAIMER:

The images and text contained in this material are believed to be accurate at the time of printing. However, details, specifications, or information may change without notice. The publisher or author assumes no responsibility for any errors, omissions, or changes that occur after the date of printing.



WE ARE A CARBON NEUTRAL COMPANY

[#carbonneutralbritain / carbonneutralbritain.org](#)

Carbon
Neutral
Britain™



Cheapest Spill Pad Kit on NHS Supply Chain...

Protect Patients. Protect Staff. Secure the Spill.



**Compliant
& Safe**



**Patient &
Staff Friendly**



**Cost-Effective
Safety**



**Immediate
Response**



NHS Supply Chain: [Spill Pad Kit] MKO85182

About Us

We are founded on the belief that life matters and that there are always ways to make life better. Every day, everywhere, we strive to meet this aim by making a positive difference to people's lives.

At Nine Group, we aim to be a beacon and make an impact at scale. From the outset, we harness our diverse skills and in collaboration with our customers and experts relentlessly look to expand what is possible, effective and can be clinically proven, when it comes to infection control and management.

From inception to delivery we are committed to delivering the most progressive and valuable solutions, in a way and at a time that our customers want, underpinned by simple and clear facts so our people can make informed decisions.

**Together—
We Make Life Better.**

How we work

The process which sets us apart & forms great, long lasting, partnerships with our clients.



Contact:

Contact with our clients is either made proactively or reactively. We want to see how we can help make making your day-to-day life easier, by solving problems & challenges.

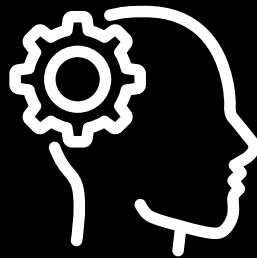

Understanding Our Clients:

We like to fully understand your requirements in detail and discuss your challenges to offer tailored solutions providing as much value to you as possible. We are not just another supplier; we like to form long lasting partnerships.



Supporting Clients:

Supporting you in every way to provide a great solution or solve a problem is what drives us each day to make a difference and set us apart.



Order Placed:

Once orders are placed, your client care executive, goes above and beyond to ensure this is processed, picked, packed and dispatched as quickly and efficiently as possible.

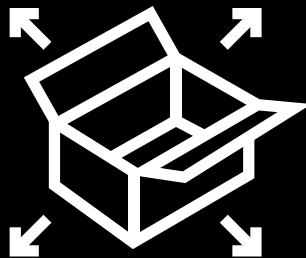

Delivery:

Your order is delivered fast, using sustainable packaging options. For example, using our recycled plastic, re-usable totes reduces the amount of cardboard you have to discard and we have to use as an organisation. Our own delivery vehicles offer real-time tracking and a detailed proof of delivery.

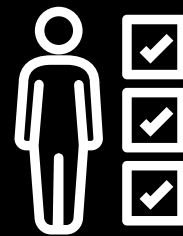

Follow Up:

We are obsessed with follow up, to constantly get feedback and ensure your 110% satisfied with the service and care your receiving. Regularly keeping in touch ensures we can help and support with any new challenges or problems which may arise.

Our Four Pillar Partnership Methodology



Pillars are the support that holds up any building, but they are also the support that holds up a company. Like with construction, the pillars of a company must be strong, effective, and beneficial to every aspect of the business.

We at Nine Group have identified four pillars that we believe are the most important and vital in supporting your company and services. They are innovative products, sustainability, logistics/operations, and an all-in-one solution.

All-In-One Solution

Along with our Medi9 range being an all-in-one infection control solution, Nine Group itself is, in fact, the same. We are dedicated to providing everything needed in terms of medical consumables, equipment, infection control, decontamination systems, furniture, PPE, cleaning, janitorial and patient care to name a few.

Along with being more sustainable, an all-in-one solution saves you time and money through eliminating the need for multiple suppliers and deliveries.

Innovative Products

We supply and manufacture a wide range of products through a variety of categories and are always looking for what is new, updated, and innovative to help our clients be more efficient in what they do, add value, and bring about cost savings where possible.

Logistics/Operations

Nine Group offer a service to handle all logistics and operations for clients who have large requirements to carry out their day to day services. This reduces our clients' stress of background responsibilities and allows them to focus more on their business while we take care of the rest.

Using robust, reliable supply chains, clients will receive the products when required, on our fleet of vehicles to ensure the product is delivered every time and in good condition.

Sustainability

Companies around the globe are making moves to become more sustainable, and Nine Group are no exception. We have policies and plans in place to become more sustainable in all aspects of the company, which includes fully electrical vehicles as part of our delivery fleet, paper-free offices, and fully recyclable packaging/products where possible.

We have implemented a reusable tote service, which has made amazing progress in reducing the amount of cardboard that requires disposal. The totes are made with 100% recycled plastic and are used in conjunction with our fleet of delivery vehicles, which in turn reduce the number of deliveries a client receives.

Logistics & Tracking

Track POD is a fully automated system which all drivers are trained on and provides a fully detailed Proof of Delivery document to both us and our clients.

This has already been extremely beneficial to all clients that have used our service, and we have received great feedback, especially as our new system allows our clients to provide key codes for driver access out of hours. Then, by providing our photo proof of delivery, you can see that your order has been delivered accurately and safely.

We are looking to further advance this system by allowing clients to log in to the system from their end and track our vehicles within the hour of delivery, so the delivery is entirely trackable for both us and our clients.

We decided to implement this system for a number of reasons, but mainly using feedback from our platinum clients after asking how we could improve to make the delivery process easier for them. Also, in our bid to become more sustainable, the system allows us to take a further step to becoming a paperless company, something we are working towards in the next 5 years.

With the Track POD system, our Logistics team now have full control over the route planning of each

delivery vehicle within our fleet. This, again, enables us to plan the routes more efficiently to help in sustainability. Our drivers are directly employed by Nine Group enabling us to carry out various required checks to guarantee great client care.

The proof of delivery document is sent to both the client and us in PDF form via email, which is, like most of our systems, customisable to the client's needs and requirements.

Features:

- Our clients' order reference number
- Quantity of Packages
- All line items that are in the delivery
- Weight of delivery
- Name of driver
- Time and date of delivery
- Photo proof of delivery
- Name and signature of signatory
- Delivery vehicle registration

Track-POD Proof of Delivery

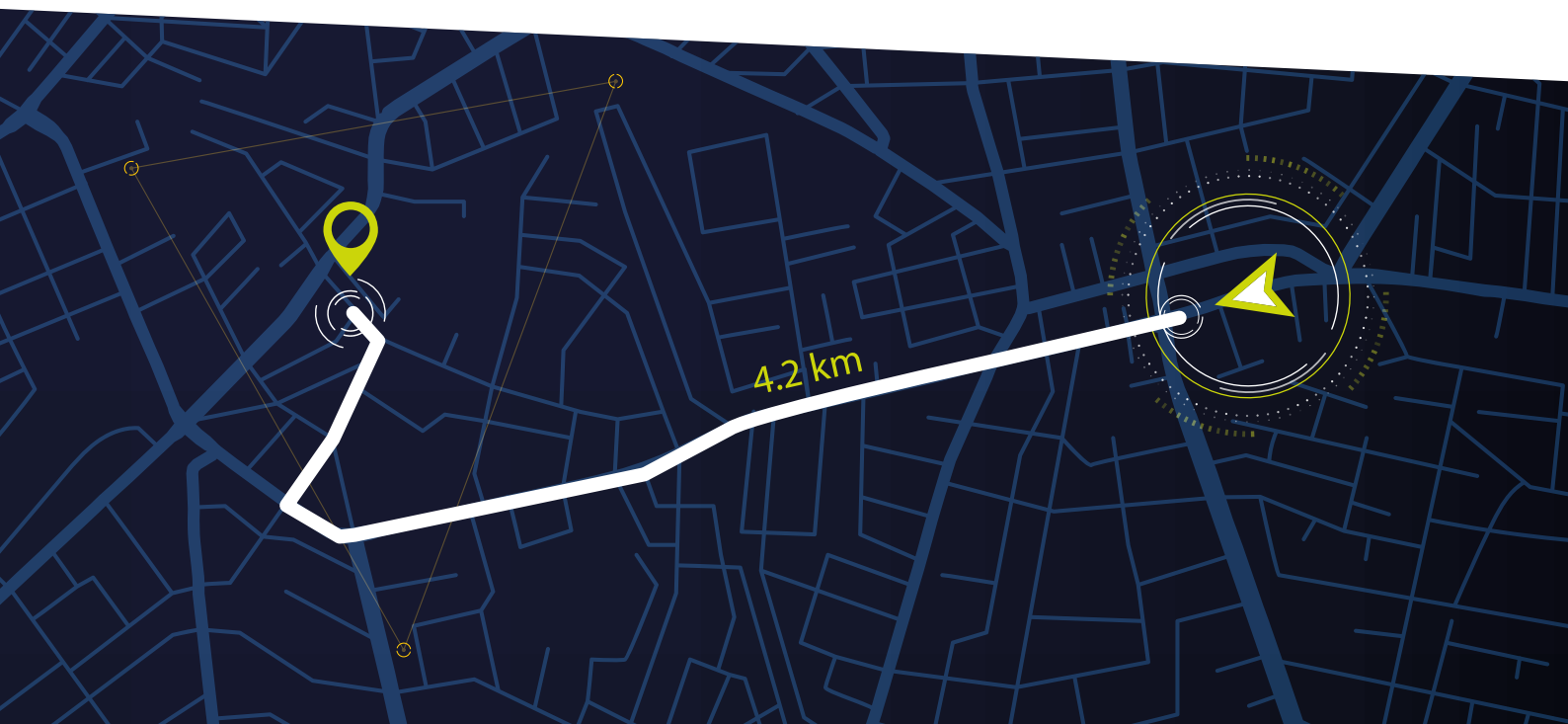



Make Ready / IPC Areas

The complete in-house service for transforming your work place area's into a safe, bespoke designed & built.

From Survey:

This initial step can be done by either sending us the dimensions using our Survey form, along with additional photographs of the area or by site visit to your premises and carrying out a site survey.

The visual:

Once the dimensions / site survey is complete and we have discussed what your requirements are, we will produce a full CAD design and rendering showing you your new Make Ready / IPC Area. At this point you will be able to make alterations to the design.

Reality:

Once the CAD design / rendering, equipment & wall artwork have all been approved and signed off, our team will then transform the specified area into your new Make Ready / IPC Area.

- **Features:**
- — Making sure everything you require is in one safe place
- — Customisable to your requirements
- — Wall Artwork / Signage
- — Fully plumbed & ready to go
- — Storage systems
- — Fully Equipped & Stocked

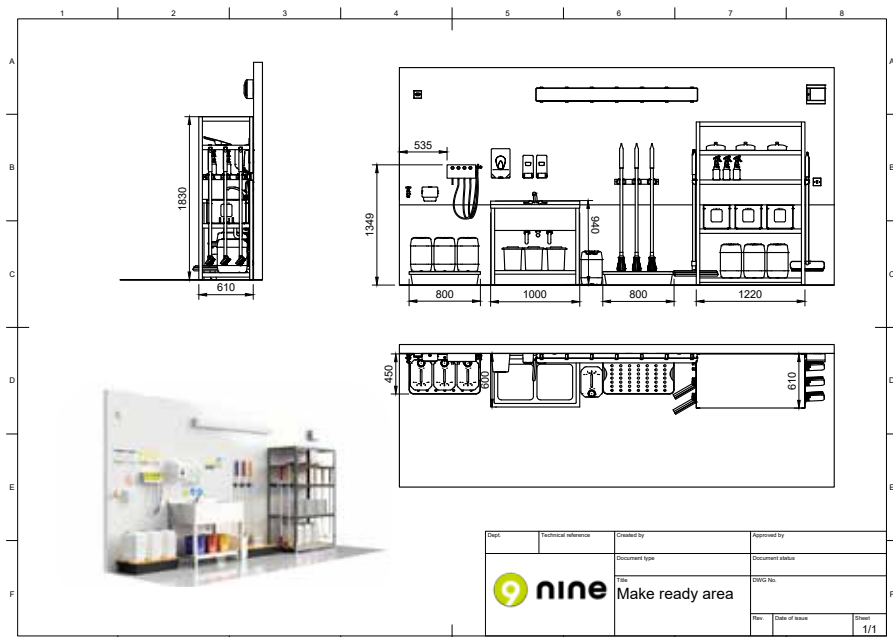

Additional Services

We pride ourselves in making a positive difference to people's lives. From inception to delivery we are committed to delivering the most progressive and valuable solutions to you the customer.

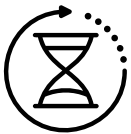

24/7 In-House Nine Group Delivery Service

We have expanded our in-house delivery team and fleet to enable a 24/7 direct, fast, and secure delivery service to mobile and static sites with our own vehicles and drivers for our platinum customers.

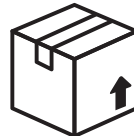

Base / Healthcare Establishment in a Box

Our easy All-In-One Complete Kit offers one complete delivery of everything required to kit-out a space, whether it is a new medical room, a clinic, a mobile base upgrade or simply a complete restock.



Site Audits

We offer site audits and consultations to help our clients achieve and maintain clean and healthy environments in the most effective way.



Service and Maintenance

We set high standards and all our equipment comes with a standard 12-month warranty. In addition, we offer service and warranty extensions as well as packaged, ad-hoc and emergency services. Our in-house team of technicians and engineers do this 24hrs, 7 days a week, 365 days a year.

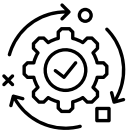

Trials and Testing

All our products have been extensively tested and we have a significant trial and testing data, which are available upon request. We appreciate that at times you may want to conduct your own testing and trials and we collaborate with our customers to facilitate their own in-house testing, if and when desired.



Stock Holding

We have significant in-house stock holding capabilities at our Head office to allow for rapid dispatch of critical items on behalf of our main clients and also offer additional flexible ad-hoc local warehouse and stock holding options and services at client sites.



Product Development

In collaboration with our customers and experts, we relentlessly look to expand what is possible, effective, and can be clinically proven, when it comes to infection control and management. We are analytical and constantly ask ourselves is there something new or better, which would considerably improve today's options and work extensively with our clients on product development.



Product Training

We provide online, virtual and in person product training to run through choices and best practice



**Genuinely
caring about
people and life.**



ninegrp.com



Wanting a bespoke trolley to actually meet your needs? Book a time to see your own configuration.

www.ninegrp.com/livedemo or call 01726 813919



SCAN TO BOOK



Trolleys

**The future
for cleaning
healthcare
environments
has arrived...**

01.

Bespoke Trolley Systems

We design and build trolley's to your specific requirements. Helping your team work more efficiently and adding real value where it matters.

02.

Reducing Costs

Providing cost efficiencies over against the system or systems you are currently using.

03.

Providing Team Efficiency

Providing a solution or system that your team love and that makes them most efficient in their day to day activities.

The following range represents just a few of the most popular off-the-shelf configurations...

TTS NHSC1 Magic Line Trolley 330B

Trolley with 2 areas: 120L foldable bag holder and storage area with drawer. Multipurpose polypropylene trolley, modular and customisable to meet every cleaning need. Ideal to carry cleaning tools in environments with space-saving needs, thanks to the foldable bag holder.

[PLEASE NOTE: Bag and lid not included]



- Features:**
- Hygienic: the plastic frames separate the trolley modules avoiding contamination between the washing, storage and waste collection area
 - Shock-resistant: polypropylene, naturally stainless and elastic, shockproof performance
 - Modular: components and accessories allow you to customize the trolley for every need, making it easy to update or repair at any time
 - Easy to maintain: the smooth surfaces and the absence of cavities facilitate cleaning and guarantee a high level of hygiene

TTS - NHSC1 - Magic Line Trolley 330B

Medium size for easy storage. Rear foldable waste collection area with removable support shelf for easy storage, 120L capacity, open storage area with 1x22L Drawer, basket above with 4x 4L Buckets R/B/G/Y. Front Open space to carry Mop bucket or other tools.

SKU:	Size:
NG 12040551 NHSSC MKO85223	97x55x145cm [Sizes with closed bag holder]

TTS NHSC2 - Magic Line Trolley 330S

Trolley with 2 areas: 120L foldable bag holder and storage area with drawer. Multipurpose polypropylene trolley, modular and customisable to meet every cleaning need. Ideal to carry cleaning tools in environments with space-saving needs, thanks to the foldable bag holder.

[PLEASE NOTE: Bag and lid not included]



- Features:**
- Hygienic: the plastic frames separate the trolley modules avoiding contamination between the washing, storage and waste collection area
 - Shock-resistant: polypropylene, naturally stainless and elastic, shockproof performance
 - Modular: components and accessories allow you to customize the trolley for every need, making it easy to update or repair at any time
 - Easy to maintain: the smooth surfaces and the absence of cavities facilitate cleaning and guarantee a high level of hygiene
 - Safety: key system to safely manage the trolley
 - Customisable: the panels of the trolley

TTS - NHSC2 - Magic Line Trolley 330S

Medium size for easy storage. Rear Foldable waste collection area with removable support shelf for easy storage, 120L capacity. Lockable storage area with 1x22L Drawer, basket above with 4x 4L Buckets R/B/G/Y. Front Open space to carry Mop bucket or other tools.

SKU:	Size:
NG 12040552 NHSSC MKO85194	97x55x145cm [Sizes with closed bag holder]

TTS NHSC3 – Magic Line Trolley 350S

Multipurpose polypropylene trolley, modular and customisable to meet every cleaning need. Ideal to carry cleaning tools in environments with space-saving needs, thanks to the foldable bag holder.

[PLEASE NOTE: Bag and lid not included]



Features:

- Hygienic: the plastic frames separate the trolley modules avoiding contamination between the washing, storage and waste collection area
- Shock-resistant: polypropylene, naturally stainless and elastic, shockproof performance
- Modular: components and accessories allow you to customize the trolley for every need, making it easy to update or repair at any time
- Easy to maintain: the smooth surfaces and the absence of cavities facilitate cleaning and guarantee a high level of hygiene
- Safety: key system to safely manage the trolley
- Customisable: the panels of the trolley

TTS – NHSC3 – Magic Line Trolley 350S

Medium size for easy storage – Rear Foldable waste collection area with removeable support shelf for easy storage, 120L capacity – Lockable storage area with 1x22L Drawer, basket above with 4x 4L Buckets R/B/G/Y – Front 2x 15L buckets with Tec wringer [Flat Mop and string Mop compatible].

SKU:

Size:

NG	12040553	97x65x145cm
NHSCC	MKO85173	[Sizes with closed bag holder]

TTS NHSC4 – Magic Line Trolley 450S

Multipurpose polypropylene trolley, modular and customisable to meet every cleaning need. Ideal to carry cleaning tools in environments with space-saving needs, thanks to the foldable bag holder.

[PLEASE NOTE: Bag and lid not included]



Features:

- Hygienic: the plastic frames separate the trolley modules avoiding contamination between the washing, storage and waste collection area
- Shock-resistant: polypropylene, naturally stainless and elastic, shockproof performance
- Modular: components and accessories allow you to customize the trolley for every need, making it easy to update or repair at any time
- Easy to maintain: the smooth surfaces and the absence of cavities facilitate cleaning and guarantee a high level of hygiene
- Safety: key system to safely manage the trolley
- Discrete: soft closing lid
- Customisable: the panels of the trolley

TTS – NHSC4 – Magic Line Trolley 450S

Medium size for easy storage – Rear Foldable waste collection area with removeable support shelf for easy storage, 120L capacity – Lockable storage area with 1x22L Drawer, Lockable basket above with 4x 4L Buckets R/B/G/Y – Front 2x 15L buckets with Tec Wringer [Flat Mop and string Mop compatible].

SKU:

Size:

NG	12040554	97x65x145cm
NHSCC	MKO85208	[Sizes with closed bag holder]

TTS NHSD1 – Magic Line Trolley 200B

Trolley with 2 areas: 120L foldable bag holder and storage area with drawer. Multipurpose polypropylene trolley, modular and customisable to meet every cleaning need. Ideal to carry cleaning tools in environments with space-saving needs, thanks to the foldable bag holder.
[PLEASE NOTE: Bag and lid not included]



- Features:**
- Hygienic: the plastic frames separate the trolley modules avoiding contamination between the washing, storage and waste collection area
 - Shock-resistant: polypropylene, naturally stainless and elastic, guarantees shockproof performance
 - Modular: components and accessories allow you to customize the trolley for every need, making it easy to update or repair at any time
 - Easy to maintain: the smooth surfaces and the absence of cavities facilitate cleaning and guarantee a high level of hygiene

TTS – NHSD1 – Magic Line Trolley 200B

Compact size for easy storage. Rear Foldable waste collection area with removable support shelf for easy storage, 120L capacity. Open storage area with 1x22L Drawer, basket above with 4x 4L Buckets R/B/G/Y.

SKU:	Size:
NG 12040555 NHSSC MKO85190	64x55x145cm [Sizes with closed bag holder]

TTS NHSD2 – Magic Line Trolley 200S

Trolley with 2 areas: 120L foldable bag holder, closed storage area with drawer. Multipurpose polypropylene trolley, modular and customisable to meet every cleaning need. Ideal to carry cleaning tools in environments with space-saving needs, thanks to the foldable bag holder.
[PLEASE NOTE: Bag and lid not included]



- Features:**
- Hygienic: the plastic frames separate the trolley modules avoiding contamination between the washing, storage and waste collection area
 - Shock-resistant: polypropylene, naturally stainless and elastic, guarantees shockproof performance
 - Modular: components and accessories allow you to customize the trolley for every need, making it easy to update or repair at any time
 - Easy to maintain: the smooth surfaces and the absence of cavities facilitate cleaning and guarantee a high level of hygiene
 - Safety: key system to safely manage the trolley
 - Customisable: the panels of the trolley

TTS – NHSD2 – Magic Line Trolley 200S

Rear Foldable waste collection area with removable support shelf for easy storage, 120L capacity. Lockable storage area with 1x22L Drawer, basket above with 4x 4L Buckets R/B/G/Y.

SKU:	Size:
NG 12040556 NHSSC MKO85201	64x55x145cm [Sizes with closed bag holder]

TTS NHSD3 – Magic Line Trolley 250S

Trolley with 2 areas: 120L foldable bag holder, closed storage area with drawer. Multipurpose polypropylene trolley, modular and customisable to meet every cleaning need. Ideal to carry cleaning tools in environments with space-saving needs, thanks to the foldable bag holder.

[PLEASE NOTE: Bag and lid not included]



Features:

- Hygienic: the plastic frames separate the trolley modules avoiding contamination between the washing, storage and waste collection area
- Shock-resistant: polypropylene, naturally stainless and elastic, guarantees shockproof performance
- Modular: components and accessories allow you to customize the trolley for every need, making it easy to update or repair at any time
- Easy to maintain: the smooth surfaces and the absence of cavities facilitate cleaning and guarantee a high level of hygiene
- Safety: key system to safely manage the trolley
- Customisable: the panels of the trolley
- Discrete: soft closing lid

TTS – NHSD3 – Magic Line Trolley 250S

Rear Foldable waste collection area with removable support shelf for easy storage, 120L capacity. Lockable storage area with 1x22L Drawer, Lockable basket above with 4x 4L Buckets R/B/G/Y.

SKU:

Size:

NG **12040557**
NHSSC **MKO85216**

64x55x140cm
[Sizes with closed bag holder]

NG: 13040122 / NHSSC: MKO85225



**One case.
Simple & easy.
The Definitive Kit.**

Uni9 Spill Kit For Blood
& Urine in a Case

See page 189

TTS NHSE1 – Magic Line Trolley 700B

Trolley with 3 areas: 120L foldable bag holder, closed storage area with 2 drawers and washing area with pre-soaking system. Multipurpose polypropylene trolley, modular and customisable to meet every cleaning need. Ideal for high-performance professional cleaning in environments with two different degrees of risk and when you need a space-saving trolley thanks to the foldable bag holder.

[PLEASE NOTE: Bag and lid not included]



Features:

- Hermetic closure: buckets with hook system between bucket and lid
- Hygienic: the plastic frames separate the trolley modules avoiding contamination between the washing, storage and waste collection area
- Shock-resistant: polypropylene, naturally stainless and elastic, shockproof performance
- Modular: components and accessories allow you to customize the trolley for every need, making it easy to update or repair at any time
- Easy to maintain: the smooth surfaces and the absence of cavities facilitate cleaning and guarantee a high level of hygiene

NHSE1 – Magic Line Trolley 700B

Compact size for easy storage - Rear Foldable waste collection area with removable support shelf for easy storage, 120L capacity - Open storage area with 1x22L Drawer, basket above with 4x 4L Buckets with lids R/B/G/Y - Front 2x lateral baskets with 2x 20L Hermetic Buckets with lids R/B

SKU:

Size:

NG **12040558**
NHSSC **MKO85191**

84x58x147cm
[Sizes with closed bag holder]

TTS NHSE2 – Magic Line Trolley 700S

Trolley with 3 areas: 120L foldable bag holder, closed storage area with drawer and washing area with pre-soaking system. Multipurpose polypropylene trolley, modular and customisable to meet every cleaning need. Ideal for high-performance professional cleaning in environments with two different degrees of risk and when you need a space-saving trolley thanks to the foldable bag holder.

[PLEASE NOTE: Bag and lid not included]



Features:

- Hermetic closure: buckets with hook system between bucket and lid
- Hygienic: the plastic frames separate the trolley modules avoiding contamination between the washing, storage and waste collection area
- Shock-resistant: polypropylene, naturally stainless and elastic, shockproof performance
- Modular: components and accessories allow you to customize the trolley for every need, making it easy to update or repair at any time
- Easy to maintain: the smooth surfaces and the absence of cavities facilitate cleaning and guarantee a high level of hygiene
- Safety: key system to safely manage the trolley
- Customisable: the panels of the trolley

NHSE1 – Magic Line Trolley 700S

Compact size for easy storage - Rear Foldable waste collection area with removable support shelf for easy storage, 120L capacity - Lockable storage area with 1x22L Drawer, basket above with 4x 4L Buckets with lids R/B/G/Y - Front 2x lateral baskets with 2x 20L Hermetic Buckets with lids R/B

SKU:

Size:

NG **12040559**
NHSSC **MKO85158**

84x58x147cm
[Sizes with closed bag holder]

TTS NHSE3 - Magic Line Trolley 740S

Trolley with 3 areas: 120L foldable bag holder, closed storage area with drawer and washing area with pre-soaking system. Multipurpose polypropylene trolley, modular and customisable to meet every cleaning need. Ideal for high-performance professional cleaning in environments with two different degrees of risk and when you need a space-saving trolley thanks to the foldable bag holder.

[PLEASE NOTE: Bag and lid not included]

1 Most popular config in the NHS



Features:

- Hermetic closure: buckets with hook system between bucket and lid
- Hygienic: the plastic frames separate the trolley modules avoiding contamination between the washing, storage and waste collection area
- Shock-resistant: polypropylene, naturally stainless and elastic, shockproof performance
- Modular: components and accessories allow you to customize the trolley for every need, making it easy to update or repair at any time
- Easy to maintain: the smooth surfaces and the absence of cavities facilitate cleaning and guarantee a high level of hygiene
- Safety: key system to safely manage the trolley
- Discrete: the soft closing lid
- Customisable: the panels of the trolley

TTS - NHSE1 - Magic Line Trolley 740S

Compact size for easy storage - Rear Foldable waste collection area with removable support shelf for easy storage, 120L capacity - Lockable storage area with 1x22L Drawer, Lockable basket above with 4x 4L Buckets R/B/G/Y - Front 2x lateral baskets with 2x 20L Hermetic Buckets with lids R/B

SKU:

Size:

NG **12040560**
NHSSC **MKO85195**

84x58x147cm
[Sizes with closed bag holder]



Powerful. Strong on Dirt. Sustainable.

Features:

- ☑ Wipes 90% recycled content
- ☑ Made here in Great Britain for greater control
- ☑ Sustainable System: Tub / Refills

See page 152

TTS NHSF1 – Magic Line Trolley 300B

Trolley with 2 areas: 120L bag holder and storage area with drawer. Multipurpose polypropylene trolley, modular and customisable to meet every cleaning need. Ideal to carry cleaning tools.
 [PLEASE NOTE: Bag and lid not included]



- Features:**
- Hygienic: the plastic frames separate the trolley modules avoiding contamination between the washing, storage and waste collection area
 - Shock-resistant: polypropylene, naturally stainless and elastic, guarantees shockproof performance
 - Modular: components and accessories allow you to customize the trolley for every need, making it easy to update or repair at any time
 - Easy to maintain: the smooth surfaces and the absence of cavities facilitate cleaning and guarantee a high level of hygiene

NHSF1 – Magic Line Trolley 300B

Large - Rear waste collection area with support shelf, 120L capacity - Open storage area with 1x 22L Drawer, basket above with 4x 4L Buckets R/B/G/Y

SKU:	Size:
NG 12040561 NHSSC MKO85196	92x55x110cm

TTS NHSF2 – Magic Line Trolley 300S

Trolley with 2 areas: 120L bag holder and closed storage area with drawer. Multipurpose polypropylene trolley, modular and customisable to meet every cleaning need. Ideal to carry cleaning tools.
 [PLEASE NOTE: Bag and lid not included]



- Features:**
- Hygienic: the plastic frames separate the trolley modules avoiding contamination between the washing, storage and waste collection area
 - Shock-resistant: polypropylene, naturally stainless and elastic, guarantees shockproof performance
 - Modular: components and accessories allow you to customize the trolley for every need, making it easy to update or repair at any time
 - Easy to maintain: the smooth surfaces and the absence of cavities facilitate cleaning and guarantee a high level of hygiene
 - Safety: key system to safely manage the trolley
 - Customisable: the panels of the trolley

NHSF2 – Magic Line Trolley 300S

Large - Rear waste collection area with support shelf, 120L capacity - Lockable storage area with 1x 22L Drawer, basket above with 4x 4L Buckets R/B/G/Y

SKU:	Size:
NG 12040562 NHSSC MKO85192	92x55x110cm

TTS NHSF3 – Magic Line Trolley 470S

Trolley with 2 areas: 120L bag holder and closed storage area with 2 drawer. Multipurpose polypropylene trolley, modular and customisable to meet every cleaning need. Ideal to carry cleaning tools in environments where the material should be kept safely in the trolley.

[PLEASE NOTE: Bag and lid not included]



Features:

- Hygienic: the plastic frames separate the trolley modules avoiding contamination between the washing, storage and waste collection area
- Shock-resistant: polypropylene, naturally stainless and elastic, guarantees shockproof performance
- Modular: components and accessories allow you to customize the trolley for every need, making it easy to update or repair at any time
- Easy to maintain: the smooth surfaces and the absence of cavities facilitate cleaning and guarantee a high level of hygiene
- Safety: key system to safely manage the trolley
- Discrete: the soft closing lid
- Customisable: the panels of the trolley

NHSF3 – Magic Line Trolley 470S

Large - Rear waste collection area with support shelf, 120L capacity - Lockable storage area with 1x 22L Drawer, Lockable basket above with 4x 4L Buckets R/B/G/Y

SKU:

Size:

NG **12040563**
NHSSC **MKO85189**

92x55x105 cm



Clean faster. Disinfect smarter.

Uni9 Multi Purpose Range

- ✔ Multi-surface cleaning & disinfecting for high-traffic areas
- ✔ The Go-To solution for Catering

See pages 96 to 97 & 153

TTS NHSG1 – Magic Line Trolley 300E

Closed trolley with 2 areas: 150L bag holder and storage area with drawer. Multipurpose polypropylene trolley, modular and customisable to meet every cleaning need. Ideal to carry cleaning tools.



Features:

- Hygienic: the plastic frames separate the trolley modules avoiding contamination between the washing, storage and waste collection area
- Shock-resistant: polypropylene, naturally stainless and elastic, guarantees shockproof performance
- Modular: components and accessories allow you to customize the trolley for every need, making it easy to update or repair at any time
- Easy to maintain: the smooth surfaces and the absence of cavities facilitate cleaning and guarantee a high level of hygiene
- Safety: key system to safely manage the trolley
- Discrete: the soft closing lid
- Customisable: the panels of the trolley

TTS – NHSG1 – Magic Line Trolley 300E

Rear Enclosed waste collection area with support shelf, 150L capacity – Lockable storage area with 1x 22L Drawer, basket above with 4x 4L Buckets R/B/G/Y

SKU:

Size:

NG	12040564	98x60x110cm
NHSSC	MKO85193	

TTS NHSG2 – Magic Line Trolley 470E

Large rear enclosed waste collection area with support shelf, 150L capacity. Lockable storage area with 1x 22L Drawer, Lockable basket above with 4x 4L Buckets R/B/G/Y.

[PLEASE NOTE: Bag and lid not included – Possibility to apply a pedal set]



Features:

- Hygienic: the plastic frames separate the trolley modules avoiding contamination between the washing, storage and waste collection area
- Shock-resistant: polypropylene, naturally stainless and elastic, guarantees shockproof performance
- Modular: components and accessories allow you to customize the trolley for every need, making it easy to update or repair at any time
- Easy to maintain: the smooth surfaces and the absence of cavities facilitate cleaning and guarantee a high level of hygiene
- Safety: key system to safely manage the trolley
- Discrete: the soft closing lid
- Customisable: the panels of the trolley

TTS – NHSG2 – Magic Line Trolley 470E

Rear Enclosed waste collection area with support shelf, 150L capacity – Lockable storage area with 1x 22L Drawer, Lockable basket above with 4x 4L Buckets R/B/G/Y

SKU:

Size:

NG	12040565	96x55 x105cm
NHSSC	MKO85200	

TTS NHSA2 – Nick Hermetic 106

Trolley with “U” handle, double frame, 2x10L Hermetic buckets, ø 80 mm wheels with bumpers, 2 Rilsan painted grids and handle holder. Washing trolley for pre-soaking system, with bag holder for dirty mops collection. Ideal for high-performance professional cleaning in environments with two different degrees of risk.



Features:

- – Hermetic closure: buckets with hook system between bucket and lid and a special gasket that ensure an airtight seal
- – Shock-resistant: one-piece frame entirely made of plastic, guarantees lightness, strength and increased lifespan
- – Easy to maintain: the smooth surfaces and the absence of cavities facilitate cleaning and guarantee a high level of hygiene
- – Easy to assemble: without screws

TTS – NHSA2 – Nick Hermetic 106

Compact size for easy storage – Rear waste collection area – Front 2x 10L Hermetic Buckets with Lid R/B

SKU:	Size:
NG 12040545-0102	92x55x110cm
NHSSC MKO85234	

TTS NHSA1 – Nick Hermetic 125

Trolley with “U” handle, double frame, 2x10L Hermetic buckets, ø 80 mm wheels with bumpers, 2 Rilsan painted grids and handle holder. Washing trolley for pre-soaking system, with bag holder for dirty mops collection. Ideal for high-performance professional cleaning in environments with two different degrees of risk.

[PLEASE NOTE: Bag not included]



Features:

- – Hermetic closure: buckets with hook system between bucket and lid and a special gasket that ensure an airtight seal
- – Shock-resistant: one-piece frame entirely made of plastic, guarantees lightness and strength and increased lifespan
- – Easy to maintain: the smooth surfaces and the absence of cavities facilitate cleaning and guarantee a high level of hygiene
- – Easy to assemble: without screws

TTS – NHSA1 – Nick Hermetic 125

Compact size for easy storage – Rear waste collection area – Centre 2x storage compartments, 1x 4L Bucket Blue – Front 1x 10L Hermetic Bucket with Lid Blue

SKU:	Size:
NG 12040545-02	92x55x110cm
NHSSC MKO85235	

TTS NHSB1 – Cleaning Trolley Basic Medium

Trolley with 100mm wheels and metal varnished frames. Multipurpose polypropylene and metal trolley, customisable to meet every cleaning need. Ideal to carry cleaning tools.

[PLEASE NOTE: Bag and lid not included]



- Features:**
- Shock-resistant: polypropylene, naturally stainless and elastic, guarantees shockproof performance
 - Modular: components and accessories allow you to customize the trolley for every need, making it easy to update or repair at any time
 - Easy to maintain: the smooth surfaces and the absence of cavities facilitate cleaning and guarantee a high level of hygiene
 - Customisable: two labels on the base of the trolley can carry the logo of the cleaning company

TTS – NHSB1 – Cleaning Trolley Basic Medium

Each Waste Stream 120L waste capacity Two Storage Baskets C/w Storage buckets as shown

SKU:	Size:
NG 12040546-0102 NHSSC MK085170	90x55x109cm

TTS NHSB2 – Cleaning Trolley Basic Large

Trolley with 100mm wheels and metal varnished frames. Multipurpose polypropylene and metal trolley, customisable to meet every cleaning need. Ideal to carry cleaning tools.

[PLEASE NOTE: Bag and lid not included]



- Features:**
- Shock-resistant: polypropylene, naturally stainless and elastic, guarantees shockproof performance
 - Modular: components and accessories allow you to customize the trolley for every need, making it easy to update or repair at any time
 - Easy to maintain: the smooth surfaces and the absence of cavities facilitate cleaning and guarantee a high level of hygiene
 - Customisable: two labels on the base of the trolley can carry the logo of the cleaning company

TTS – NHSB2 – Cleaning Trolley Basic Large

Each Waste Stream 120L waste capacity Three Storage Shelves C/w Storage buckets as shown

SKU:	Size:
NG 12040547-0102 NHSSC MK085214	123x55x112cm



Rethinking cleaning for the environment

Reducing production and transport emissions, using recycled raw materials and production processes free of harmful substances are just some of the steps that can be taken to reduce the environmental impacts of cleaning.

Similarly, designing products that reduce the waste of resources such as water, chemicals and energy also reduces impact and running costs. TTS is committed every day to create solutions that make cleaning more effective and efficient, without damaging environment and health.



Recycled Plastic

Environmental responsibility has always influenced TTS's choices, also with regard to raw materials: TTS products feature components made of recycled plastic, certified Second Life Plastic (PSV) by the Institute for the Promotion of Recycling Plastics (IPPR).

Unlike simple self-declarations, PSV certification applies the international ISO 14021 regulation for calculating recycled content, ensuring the quality of recycled plastics and their traceability according to EN 15343. In addition, it involves periodic surveillance by the Certification Authority to ensure compliance over time with the requirements or the maintenance of the mark.

- ✓ **Products with PSV-certified components**
- ✓ **Systems designed to save water**
- ✓ **Production and use of clean energy**
- ✓ **EU Ecolabel certified textiles and trolleys**
- ✓ **Repairable products**

**Don't forget to
look at the Dosely
systems for easy
on-demand mop
soaking...**

See page 63



Mopping



Hygiene Handle - Aluminium Screw On [125cm]

A versatile aluminium handle that can be used with mops, washable brushware and squeegees.

Heads - See pages 66 & 67

Features:

- Available with handle grip in five colours for easy colour coding.
- Screw Fit



Hygiene Handle - Aluminium - Screw On - Red [125cm]

SKU:	Size:
NG 12040262-01 NHSSC	125cm [L] ø 2.4cm



Hygiene Handle - Aluminium - Screw On - Blue [125cm]

SKU:	Size:
NG 12040262-03 NHSSC	125cm [L] ø 2.4cm



Hygiene Handle - Aluminium - Screw On - Yellow [125cm]

SKU:	Size:
NG 12040262-04 NHSSC	125cm [L] ø 2.4cm



Hygiene Handle - Aluminium - Screw On - White [125cm]

SKU:	Size:
NG 12040262-05 NHSSC	125cm [L] ø 2.4cm



Hygiene Handle - Aluminium - Screw On - Red [125cm]

SKU:	Size:
NG 12040262-01 NHSSC	125cm [L] ø 2.4cm



Hygiene Handle - Aluminium - Screw On - Blue [125cm]

SKU:	Size:
NG 12040262-02 NHSSC	125cm [L] ø 2.4cm



Hygiene Handle - Aluminium - Screw On - Green [125cm]

SKU:	Size:
NG 12040262-03 NHSSC	125cm [L] ø 2.4cm



Hygiene Handle - Aluminium - Screw On - White [125cm]

SKU:	Size:
NG 12040262-05 NHSSC	125cm [L] ø 2.4cm



Hygiene Handle - Aluminium Screw On [137cm]

A versatile aluminium handle that can be used with mops, washable brushware and squeegees.

Heads - See pages 66 & 67



Features:

- Available with handle grip in five colours for easy colour coding.
- Screw Fit



Hygiene Handle - Aluminium - Screw On - Red [137cm]

SKU:	Size:
NG HY923017R NHSSC	137cm [L] ø 2.4cm



Hygiene Handle - Aluminium - Screw On - Green [137cm]

SKU:	Size:
NG HY923017G NHSSC	137cm [L] ø 2.4cm



Hygiene Handle - Aluminium - Screw On - Blue [137cm]

SKU:	Size:
NG HY923017B NHSSC	137cm [L] ø 2.4cm



Hygiene Handle - Aluminium - Screw On - Yellow [137cm]

SKU:	Size:
NG HY923017Y NHSSC	137cm [L] ø 2.4cm



Screw On to Socket Mop Adapter



Screw On to Socket Mop Adapter

SKU:	Qty:
NG 12040260 NHSSC	1

Handle – Aluminium Socket [137cm]

A versatile aluminium handle that can be used with mops, washable brushware and squeegees.

Heads - See pages 68

Features:

- Available with handle grip in five colours for easy colour coding.
- Push Fit



Mop Handle - Aluminium - Red [137cm]

SKU:	Size:
NG HY923015R NHSSC	137cm [L] ø 2.4cm



Mop Handle - Aluminium - Blue [137cm]

SKU:	Size:
NG HY923015B NHSSC	137cm [L] ø 2.4cm



Mop Handle - Aluminium - Green [137cm]

SKU:	Size:
NG HY923015G NHSSC	137cm [L] ø 2.4cm



Mop Handle - Aluminium Yellow [137cm]

SKU:	Size:
NG HY923015Y NHSSC	137cm [L] ø 2.4cm



Looking for 'Wall Tidy' - Hangs Three Handles, available in five colours.

See page 233



TTS Aluminium Handle

Aluminium handle with hole and coloured grip, 2.3cm diameter. Handle for TTS frames. Ideal for high-performance professional cleaning.

Frames - See pages 39 to 43

Features:

- Ergonomic: thanks to the diameter of the grip designed to reduce the operator's strain and avoid pain in the hand
- Long durability: stainless material, guarantees a long product life
- Compatible with frames with ring nut



TTS - Aluminium Handle, Red Grip

SKU:	Size:	
NG	12040266-01	140cm [L]
NHSSC	MKB85254	ø 2.3cm



TTS - Aluminium Handle, Blue Grip

SKU:	Size:	
NG	12040266-02	140cm [L]
NHSSC	MKB85255	ø 2.3cm



TTS - Aluminium Handle, Green Grip

SKU:	Size:	
NG	12040266-03	140cm [L]
NHSSC	MKB85298	ø 2.3cm



TTS - Aluminium Handle, Yellow Grip

SKU:	Size:	
NG	12040266-04	140cm [L]
NHSSC	MKB85223	ø 2.3cm



TTS Telescopic Handle

Aluminium telescopic handle with hole, non-slip ergonomic grip and coloured cap. Aluminium telescopic handle. Ideal for a professional cleaning with the highest ergonomics.

Frames - See pages 39 to 43



Features:

- Ergonomic: thanks to the diameter of the grips, both central and upper, both designed to reduce operator's strain and avoid pain to the hand
- Colour coded: it is possible to code by colour the handles thanks to the plastic caps



TTS - Telescopic Handle, Red Cap
[extends from 102cm to 184cm]

SKU:	Size:
NG 12040267-01	102 to 184cm [L]
NHSSC MKB85286	ø 2.6cm [Ext] ø 2.3cm [Int]



TTS - Telescopic Handle, Blue Cap
[extends from 102cm to 184cm]

SKU:	Size:
NG 12040267-02	102 to 184cm [L]
NHSSC MKB85264	ø 2.6cm [Ext] ø 2.3cm [Int]



TTS - Telescopic Handle, Green Cap
[extends from 102cm to 184cm]

SKU:	Size:
NG 12040267-03	102 to 184cm [L]
NHSSC MKB85270	ø 2.6cm [Ext] ø 2.3cm [Int]



TTS - Telescopic Handle, Yellow Cap
[extends from 102cm to 184cm]

SKU:	Size:
NG 12040267-04	102 to 184cm [L]
NHSSC MKB85243	ø 2.6cm [Ext] ø 2.3cm [Int]



TTS - Telescopic Handle, Grey Cap
[extends from 102cm to 184cm]

SKU:	Size:
NG 12040267-11	102 to 184cm [L]
NHSSC MKB85623	ø 2.6cm [Ext] ø 2.3cm [Int]



TTS – Pocket system BLIK Lampo Frame With Block [40cm]

Blik Lampo frame in polyamide with automatic hook system, with Jack Lampo for ø 23 mm handles. Flat mopping system with pockets, to be used either pre-soaked, soaked on demand with soaking station or with handles with tank. Ideal for environments with high risk contamination.

Handles – See pages 37 & 38

Mop Heads – See pages 48 to 52, 69 & 70



Features:

- Touch-free: the detaching system avoids any contact with the dirt
- Ergonomic: the hook system of the mop eliminates unnecessary bending of the operator
- Time-saving: closing system of the frame through pedal
- Easy to maintain: cleaning of the tool is very easy and fast
- Efficient: the Lampo system allows the same handle to be used with the whole range of dusters, web brushes and frames, hooking them up in a flash

TTS – Pocket system BLIK Lampo Frame With Block [40cm]

– Includes Jack Lampo

SKU:

Size:

NG	12040409-40	40cm x 11cm
NHSSC	MKB85574	

TTS – Pocket system BLIK Frame [40cm]

Blik frame in polyamide with automatic hook system.

Flat mopping system with pockets, to be used either pre-soaked, soaked on demand with soaking station or with handles with tank. Ideal for environments with high risk contamination.

Handles – See pages 37 & 38

Mop Heads – See pages 48 to 52, 69 & 70

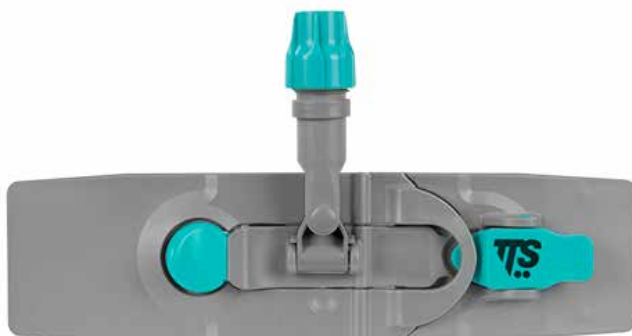

Features:

- Touch-free: the detaching system avoids any contact with the dirt
- Ergonomic: the hook system of the mop eliminates unnecessary bending of the operator
- Time-saving: closing system of the frame through pedal
- Easy to maintain: cleaning of the tool is very easy and fast

TTS – Pocket system BLIK Frame [40cm]

SKU:

Size:

NG	12040410	40cm x 11cm
NHSSC	MKB85288	

TTS – Pockety Lampo Frame [40cm]

Flat mopping system with pockets, to be used either pre-soaked, soaked on demand with soaking station or with handles with tank. Ideal for high-performance professional cleaning

Handles – See pages 37 & 38

Mop Heads – See pages 48 to 52, 69 & 70

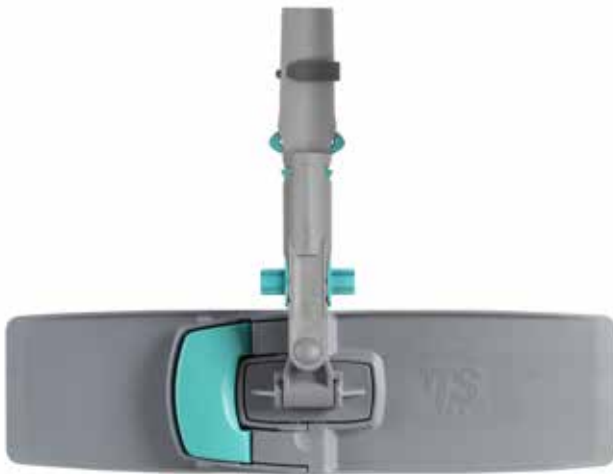

- Features:**
- Touch-free: system allows mops to be removed without contact
 - Time-saving: closing system of the frame through pedal
 - Easy to maintain: cleaning of the tool is very easy and fast
 - Efficient: the Lampo system allows the same handle to be used with the whole range of dusters, web brushes and frames

TTS – Pockety Lampo Frame [40cm]

– Includes Jack Lampo

SKU:	Size:
NG 12040417 NHSSC	40cm x 11cm

TTS – Pockety Frame – Block System [40cm]

Flat mopping system with pockets, to be used either pre-soaked, soaked on demand with soaking station or with handles with tank. Ideal for professional and high performance cleaning of horizontal and vertical surfaces.

Handles – See pages 37 & 38

Mop Heads – See pages 48 to 52, 69 & 70

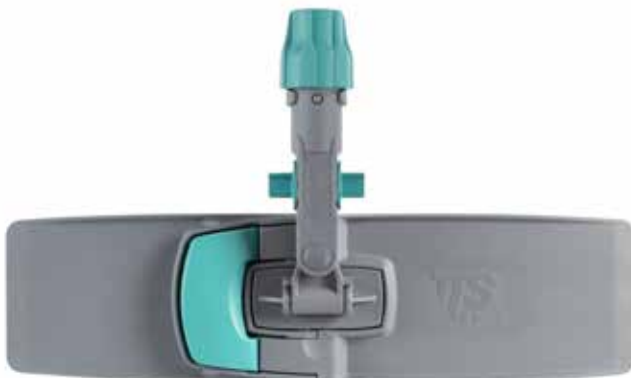

- Features:**
- Touch-free: system allows mops to be removed without contact
 - Time-saving: closing system of the frame through pedal
 - Versatile: it can be easily used to clean horizontal and vertical surfaces
 - Easy to maintain: cleaning of the tool is very easy and fast

TTS – Pockety Frame – Block System [40cm]

SKU:	Size:
NG 12040416 NHSSC	40cm x 11cm

The Ultimate Cleaner

The powerful formula kills bacteria, cleans, and deodorises in a single step – saving you time & effort.

- Fresh Lemon Scent
- Economical & Effective
- Compatible with Auto Dosing Systems

The smart choice for high-performance & professional cleaning.

See page 159



Read what **Joanne Lambert, Assistant Facilities Manager, CH Solutions** testimony

Concentrate –
Lemon 5L
MKM85035

Concentrate –
Lemon 1L Dosing Bottle
MKM85037

TTS Uni Junior System Flat Mop Frame [35cm]

Uni Junior polypropylene frame. Flat system with micro flaps, to be used with bucket with wringer Uni Bucket. Ideal for semi-professional high performance cleaning of horizontal and vertical surfaces.

Handles - See pages 37 & 38
Mop Head - See pages 54 to 58
14L Bucket - See page 80

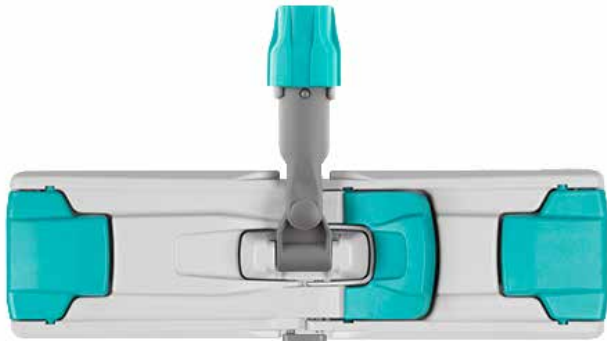

- Features:**
- Versatile: it ensures a fast and easy cleaning of horizontal and vertical surfaces
 - Handy: the easy opening system ensures a quick set-up
 - Lightweight: the lightness of the system ensures proper friction on the floor, effortlessly
 - Ergonomic: no bending during use to protect back and joint health
 - Hygienic: the used flat mop releases without any hand contact with dirt

TTS - Uni Junior System Flat Mop Frame [35cm]

SKU:	Size:
NG 12040415 NHSSC MKB85244	35cm x 10cm

TTS - Uni System Flat Mop Frame [40cm]

Uni System frame in polyamide. Flat mop system with micro-flaps, to be used with roll, jaw or flat wringer. Ideal for high-performance professional cleaning.

Handles - See pages 37 & 38
Mop Head - See pages 54 to 58



- Features:**
- Lightweight: the system is lightweight, which reduces operator's strain
 - Handy: flat mops are easy to attach thanks to the facilitated hook mechanism
 - Ergonomic: the ergonomic design of the frame ensures an easy set-up of the tool
 - Hygienic: the dirty mop can be quickly detached, without any physical contact with dirt
 - Easy to maintain: cleaning of the tool is very easy and fast

TTS - Uni System Flat Mop Frame [40cm]

SKU:	Size:
NG 12040411 NHSSC MKB85259	40cm x 11cm

TTS – Trilogy Frame [40cm]

Double-sided frame, can be used on both sides, with Block System. Flat mop system with double sided frame, to be used with pre-soaking, soaking on demand with soaking station or with the convenient wringer. Ideal for high-performance professional cleaning.

Handles - See pages 37 & 38

Mop Head - See pages 59 to 62

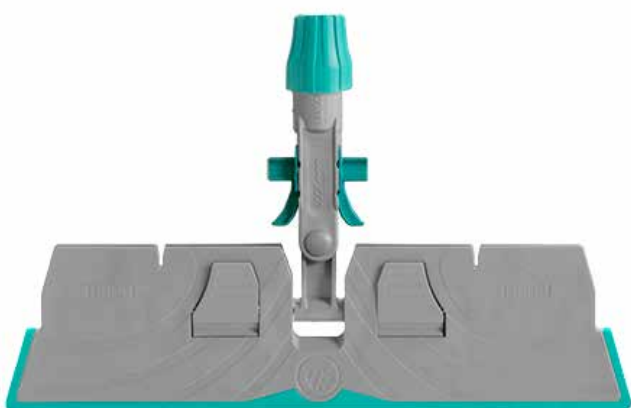

Features:

- Time-saving: you double the cleaned surface thanks to the flat mops with two cleaning sides
- If used with:
 - Pre-Soaking System - you cut the quantity of necessary mops in half thanks to the two cleaning sides
 - Wringer - you go back to the bucket to rinse and wring out the mop half the times as the two cleaning sides of the mop double the dirt collection power
- Easy: mop changing is easy & quick
- Touch-free: the detaching system avoids any contact with the dirt

TTS – Trilogy frame [40cm]
for use with double sided
Trilogy Flat Mops

SKU:

Size:

NG	12040412	40cm x 10cm
NHSSC	MKB85272	

TTS – Velook / Velco Mop Frame [40cm]

Frame with strap tape system and universal clips. Flat mopping system with frame with strap tape system, to be used either pre-soaked, soaked on demand with soaking station or with handles with tank. Ideal for high-performance professional cleaning.

Handles - See pages 37 & 38

Mop Heads - See pages 59 to 62



Features:

- Easy: mop changing is easy and quick
- Ergonomic: it is the most lightweight system of TTS range

TTS – Velook Frame [40cm]
For use with Velook &
Velcro Type Mops

SKU:

Size:

NG	12040413	40cm x 11cm
NHSSC	MKB85248	

TOUCH-FREE MOP



Touch-Free Cleaning



Maximum Hygiene

The Touch-free mop removal for safer, faster, and more hygienic cleaning in healthcare settings. Ergonomic, lightweight, and compatible with both disposable and washable pocket mops.

See page 64 & 65

Curious ? Would you like a virtual demo?

Visit www.ninegrp.com/livedemo or call **01726 813919**



SCAN TO BOOK



Speed Meets Perfection. Effortlessly Cleaning. Instant Clear.



Uni9 Glass Cleaner
Instant Clear - 750ml

NG **19041040**
NHSSC **MKJ85473**

See page 95

uni9

Fast & Effective

TTS BIO Blik Basic [40cm]

IO Basic applicator with Blik frame, bottle capacity 0,65L. Handle with tank for no-bucket-cleaning with pocket frame Ideal for hard-to-reach environments as staircases and a precise cleaning of unexpected dirt or combined with cleaning with equipments

Mop Heads - See pages 48 to 52 & 69



- Features:**
- Long durability: pocket mops last twice as much as strap tape mops
 - Touch-free: the detaching system avoids any contact with the dirt
 - Ready-to-use: the cleaning solution is hermetically kept in the dosing bottle
 - Compliant with health protocols: the cleaning solution is released onto the floor, chemicals are not sprayed in the air, as with nebulization occurs
 - Ergonomic: eliminates the use of heavy buckets and wringer making cleaning operations quick and easy
 - Compact: all you need in one single handle
 - Intuitive: easy-to-use system, fast and it requires no training
 - Easy to maintain: cleaning of the tool is very easy and fast
 - Colour coded: transparent, graduated, colour-coded bottles to diversify cleaning solutions according to the environment

TTS BIO Blik Basic Spray Wet Mop System 40cm c/w 0.65L Bottle

SKU:		Size:
NG	12040370-11	40x11x155cm
NHSSC	MKJ85785	



TTS BIO System Bottle



TTS BIO System Bottle -
0.65L - Red

SKU:

NG **12040373-01**
NHSSC **MKB85569**



TTS BIO System Bottle -
0.65L - Blue

SKU:

NG **12040373-02**
NHSSC **MKB85564**



TTS BIO System Bottle -
0.65L - Green

SKU:

NG **12040373-03**
NHSSC **MKB85568**



TTS BIO System Bottle -
0.65L - Yellow

SKU:

NG **12040373-04**
NHSSC **MKB85571**



TTS BIO System Bottle -
0.65L - Grey

SKU:

NG **12040373-11**
NHSSC **MKB85575**

TTS BIO System Caps



TTS BIO Non Slip
Cap - Red

SKU:

NG **12040372-01**
NHSSC **MKB85573**



TTS BIO Non Slip
Cap - Blue

SKU:

NG **12040372-02**
NHSSC **MKB85566**



TTS BIO Non Slip
Cap - Green

SKU:

NG **12040372-03**
NHSSC **MKB85565**



TTS BIO Non Slip
Cap - Yellow

SKU:

NG **12040372-04**
NHSSC **MKB85572**



TTS BIO Non Slip
Cap - Grey

SKU:

NG **12040372-11**
NHSSC **MKB85570**

TTS Pocket System Micro Blue Flat Mop

Microfibre flat mop highly absorbent with polyester support. Flat mopping system with pockets, to be used either pre-soaked, soaked on demand with soaking station or with handles with tank. Ideal for recurring washing of smooth surfaces

Compatible Frame - See pages 39 to 40 & 65

Mops with personalised branding options available.



- Features:**
- Washing temperature max 90°C, recommended 60°C
 - Long durability: pocket mops last twice as much as strap tape mops
 - Easy: mop changing is easy and quick
 - Highest hygiene: microfibre penetrates into the microporosity of the floor, collecting dirt and bacteria
 - Touch-free: the detaching system avoids any contact with the dirt

TTS – Pocket System Micro Blue Flat Mop, Light Blue

Removable colour coded tabs

SKU:	Size:
NG 12040233-02 NHSSC MKB85263	40cm

TTS Pocket System Micro Red Flat Mop

Microfibre flat mop highly absorbent with polyester support Flat mopping system with pockets, to be used either pre-soaked, soaked on demand with soaking station or with handles with tank. Ideal for recurring washing of smooth surfaces

Compatible Frame - See pages 39 to 40 & 65

Mops with personalised branding options available.



- Features:**
- Washing temperature max 90°C, recommended 60°C
 - Long durability: pocket mops last twice as much as strap tape mops
 - Easy: mop changing is easy and quick
 - Highest hygiene: microfibre penetrates into the microporosity of the floor, collecting dirt and bacteria
 - Touch-free: the detaching system avoids any contact with the dirt

TTS – Pocket System Micro Red Flat Mop, Red

Removable colour coded tabs

SKU:	Size:
NG 12040233-01 NHSSC MKB85226	40cm

TTS Pocket System Microriccio Flat Mop

Microfibre flat mop looped end with polyester support.

Flat mopping system with pockets, to be used either pre-soaked, soaked on demand with soaking station or with handles with tank. Ideal for any surface and for particle dirt thanks to the high dirt collection power of yarn and microfibre.

Compatible Frame - See pages 39 to 40 & 65

Mops with personalised branding options available.



Features:

- Long durability: pocket mops last twice as much as strap tape mops
- Easy: mop changing is easy and quick
- Highest hygiene: microfibre penetrates into the microporosity of the floor, collecting dirt and more than 95% of bacteria
- Touch-free: the detaching system avoids any contact with the dirt

TTS - Pocket System Microriccio Flat Mop, Blue

SKU:	Size:
NG 12040222-06 NHSSC MKB85262	40cm

TTS - Pocket System Microriccio Flat Mop, Green

SKU:	Size:
NG 12040222-03 NHSSC MKB85302	40cm

TTS - Pocket System Microriccio Flat Mop, Red

SKU:	Size:
NG 12040222-01 NHSSC MKB85274	40cm

TTS - Pocket System Microriccio Flat Mop, White

SKU:	Size:
NG 12040222-12 NHSSC MKB85245	40cm

TTS - Pocket System Microriccio Flat Mop, Yellow

SKU:	Size:
NG 12040222-04 NHSSC MKB85280	40cm

TTS Pocket System Soft Band Flat Mop

White microfibre flat mop with blue stripes, intensive action, polyester support Flat mopping system with pockets, to be used either pre-soaked, soaked on demand with soaking station or with handles with tank. Ideal for smooth or porous interior floors with greasy dirt.

Compatible Frame - See pages 39 to 40 & 65

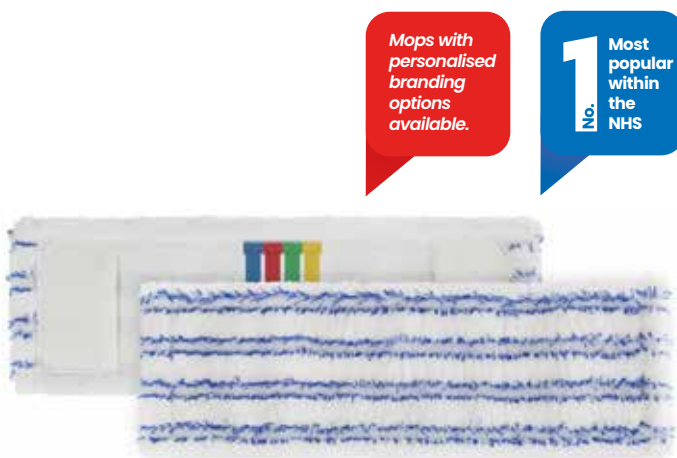

- Features:**
- Long durability: pocket mops last twice as much as strap tape mops
 - Easy: mop changing is easy and quick
 - Highest hygiene: microfibre penetrates into the microporosity of the floor, collecting dirt and more than 95% of bacteria
 - Effective: excellent intensive degreasing action of polyester on dirt without damaging surfaces
 - Touch-free: the detaching system avoids any contact with the dirt

TTS - Pocket System Soft Band Flat Mop, White/Blue Stripes

Removable colour coded tabs

SKU:	Size:
NG 12040225-02 NHSSC MKB85297	40cm

TTS Pocket System Soft Striat Flat Mop

Microfibre flat mop with stripes, polyester support. Flat mopping system with pockets, to be used either pre-soaked, soaked on demand with soaking station or with handles with tank. Ideal for smooth or porous interior floors with medium degree of dirt.

Compatible Frame - See pages 39 to 40 & 65

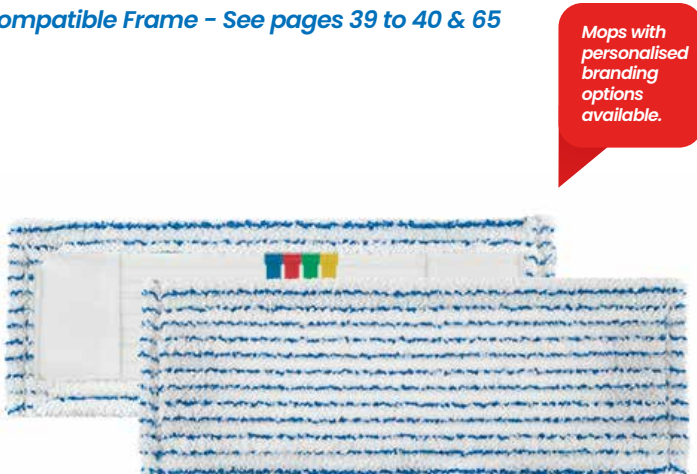

- Features:**
- Long durability: pocket mops last twice as much as strap tape mops
 - Easy: mop changing is easy and quick
 - Highest hygiene: microfibre penetrates into the microporosity of the floor, collecting dirt and more than 95% of bacteria
 - Touch-free: the detaching system avoids any contact with the dirt

TTS - Pocket System Soft Striat Flat Mop, White/Blue Stripes

Removable colour coded tabs

SKU:	Size:
NG 12040230-12 NHSSC MKB85276	40cm

TTS Pocket System Tris Flat Mop

Microfibre, polyester and cotton flat mop, looped end, polyester support. Flat mopping system with pockets, to be used either pre-soaked, soaked on demand with soaking station or with handles with tank. Ideal for any surface and kind of dirt thanks to the combination of the 3 fibres: cotton for its absorption power, microfibre for its dirt collecting power and polyester for greasy dirt and low friction

Compatible Frame - See pages 39 to 40 & 65

Mops with personalised branding options available.



- Features:**
- Long durability: pocket mops last twice as much as strap tape mops
 - Easy: mop changing is easy and quickly
 - Multipurpose: the combination of different fibres allows making many operations with one single mop
 - Highest hygiene: microfibre penetrates into the microporosity of the floor, collecting dirt and more than 95% of bacteria
 - Touch-free: the detaching system avoids any contact with the dirt.

TTS - Pocket system Tris Flat Mop

Removable colour coded tabs

SKU:	Size:
NG NHSSC	12040244-05 40cm

The smart choice for high-performance & professional cleaning.

Lemon 5L
19041015
MKM85035

Lemon 1L Dosing Bottle
19041013
MKM85037

See page 159



TTS Tri Wet 1 Mop

Double-sided mop, highly absorbent, suitable for smooth surfaces washing or drying. Flat mop system with double sided frame, to be used with pre-soaking, soaking on demand with soaking station or with the convenient wringer. Ideal for recurring washing of smooth surfaces.

Compatible Frame - See page 43

Mops with personalised branding options available.



Features:

- Time-saving: you double the cleaned surface thanks to the flat mops with two cleaning sides
- Easy: mop changing is easy and quick
- Highest hygiene: microfibre penetrates into the microporosity of the floor, collecting dirt and more than 95% of bacteria
- Touch-free: the detaching system avoids any contact with the dirt
- If used with the pre-soaking system, you cut the quantity of necessary mops in half thanks to the two cleaning sides
- If used with the wringer, you go back to the bucket to rinse and wring out the mop half the times as the two cleaning sides of the mop, doubling the dirt collection power

TTS - Trilogy Double Sided Tri Wet Flat Mop, Blue

SKU:

Size:

NG	12040231-02	46cm x 19.5cm
NHSSC	MKB85267	

TTS - Trilogy Double Sided Tri Wet Flat Mop, Green

SKU:

Size:

NG	12040231-03	46cm x 19.5cm
NHSSC	MKB85235	

TTS - Trilogy Double Sided Tri Wet Flat Mop, Red

SKU:

Size:

NG	12040231-01	46cm x 19.5cm
NHSSC	MKB85258	

TTS - Trilogy Double Sided Tri Wet Flat Mop, Yellow

SKU:

Size:

NG	12040231-04	46cm x 19.5cm
NHSSC	MKB85249	

TTS Uni Junior Soft Band Flat Mop

White microfibre flat mop with green brushed stripes with intensive action, TNT support. Flat system with micro flaps, to be used with bucket with wringer Uni Bucket. Ideal for interior smooth or safety flooring with greasy dirt.

Compatible Frame - See page 42



Features:

- Efficient: the flat mop is attached to the frame in an instant and remains fixed during use
- Highest hygiene: microfibre penetrates into the microporosity of the floor, collecting dirt and more than 95% of bacteria
- Effective: excellent intensive degreasing action of polyester on dirt without damaging surfaces
- Functional: ensures the right dampness on the floor for washing, avoiding halos and preventing slippage
- Time-saving: thanks to the large cleaning surface and the possibility of reaching corners and cleaning under furniture

TTS - Uni Junior Micro Blue Flat Mop, Light Blue

Removable colour coded tabs

SKU:	Size:
NG 12040224-12	35cm
NHSSC MKB85261	

TTS Uni System Micro Blue Flat Mop

Microfibre flat mop highly absorbent with polyester support. Flat mop system with micro-flaps, to be used with roll, jaw or flat wringer. Ideal for recurring washing of smooth surfaces.

Compatible Frame - See page 42



Features:

- Handy: flat mops are easy to attach thanks to the facilitated hook mechanism
- Safe: flat mop remains firmly attached during use, thanks to the anti-slip device
- Highest hygiene: microfibre penetrates into the microporosity of the floor, collecting dirt and more than 95% of bacteria
- Hygienic: the dirty mop can be quickly detached, without any physical contact with dirt

TTS - Uni System Micro Blue Flat Mop, Blue

Removable colour coded tabs

SKU:	Size:
NG 12040226-02	40cm
NHSSC MKB85289	

TTS Uni System Microriccio Flat Mop

Microfibre flat mop looped end with polyester support.

Flat mopping system with pockets, to be used either pre-soaked, soaked on demand with soaking station or with handles with tank. Ideal for any surface and for particle dirt thanks to the high dirt collection power of yarn and microfibre.

Compatible Frame - See page 42

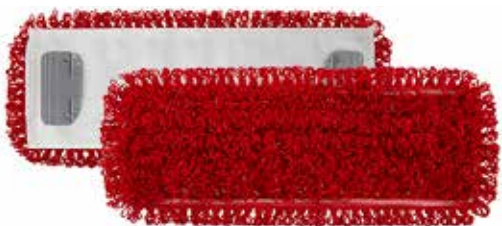

Features:

- Handy: flat mops are easy to attach thanks to the facilitated hook mechanism
- Safe: flat mop remains firmly attached during use, thanks to the anti-slip device
- Highest hygiene: microfibre penetrates into the microporosity of the floor, collecting dirt and more than 95% of bacteria
- Hygienic: the dirty mop can be quickly detached, without any physical contact with dirt

TTS - Uni System Microriccio Flat Mop, Blue

SKU:	Size:
NG 12040223-02 NHSSC MKB85250	40cm

TTS - Uni System Microriccio Flat Mop, Green

SKU:	Size:
NG 12040223-03 NHSSC MKB85278	40cm

TTS - Uni System Microriccio Flat Mop, Red

SKU:	Size:
NG 12040223-01 NHSSC MKB85279	40cm

TTS - Uni System Microriccio Flat Mop, White

SKU:	Size:
NG 12040223-05 NHSSC MKB85237	40cm

TTS - Uni System Microriccio Flat Mop, Yellow

SKU:	Size:
NG 12040223-04 NHSSC MKB85238	40cm

TTS Uni System Soft Band Flat Mop

White microfibre flat mop with blue stripes, intensive action, polyester support Flat mopping system with pockets, to be used either pre-soaked, soaked on demand with soaking station or with handles with tank. Ideal for smooth or porous interior floors with greasy dirt.

Compatible Frame - See page 42

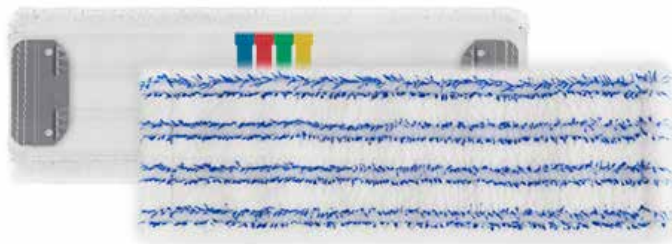

- Features:**
- Handy: flat mops are easy to attach thanks to the facilitated hook mechanism
 - Safe: flat mop remains firmly attached during use, thanks to the anti-slip device
 - Time-saving: thanks to the large cleaning surface and the possibility of reaching corners and cleaning under furniture
 - Highest hygiene: microfibre penetrates into the microporosity of the floor, collecting dirt and more than 95% of bacteria
 - Effective: excellent intensive degreasing action of polyester on dirt without damaging surfaces

TTS - Uni System Soft Band Flat Mop, White/Blue Stripes

Removable colour coded tabs

SKU:	Size:
NG 12040228-12 NHSSC MKB85234	40cm

TTS Uni System Soft Striat Flat Mop

Microfibre flat mop with stripes, polyester support. Flat mopping system with pockets, to be used either pre-soaked, soaked on demand with soaking station or with handles with tank. Ideal for smooth or porous interior floors with medium degree of dirt.

Compatible Frame - See page 42



- Features:**
- Handy: flat mops are easy to attach thanks to the facilitated hook mechanism
 - Safe: flat mop remains firmly attached during use, thanks to the anti-slip device
 - Highest hygiene: microfibre penetrates into the microporosity of the floor, collecting dirt and more than 95% of bacteria
 - Hygienic: the dirty mop can be quickly detached, without any physical contact with dirt

TTS - Uni System Soft Striat Flat Mop, White/Blue Stripes

Removable colour coded tabs

SKU:	Size:
NG 12040229-12 NHSSC MKB85221	40cm

The bin designed & built for the perfect solution

Ergonomic & customizable 'Open-Up'



Have a question and would like a virtual demo?

We can do that, schedule a time that works for you and we'll explore solutions together.

www.ninegrp.com/livedemo or call 01726 813919



SCAN TO BOOK

TTS Uni System Ultrasafe Flat Mop

Microfibre flat mop highly absorbent with polyester support Flat mop system with micro-flaps, to be used with roll, jaw or flat wringer. Ideal for recurring washing of smooth surfaces.

Compatible Frame - See page 42



- Features:**
- Handy: flat mops are easy to attach thanks to the facilitated hook mechanism
 - Safe: flat mop remains firmly attached during use, thanks to the anti-slip device
 - Highest hygiene: microfibre penetrates into the microporosity of the floor, collecting dirt and more than 95% of bacteria
 - Hygienic: the dirty mop can be quickly detached, without any physical contact with dirt

TTS - Uni System Ultrasafe Flat Mop, Blue

Removable colour coded tabs

SKU:	Size:
NG 12040227-02 NHSSC MKB85236	40cm

TTS - Uni System Ultrasafe Flat Mop, Red

Removable colour coded tabs

SKU:	Size:
NG 12040227-01 NHSSC MKB85277	40cm



Have a question? Call on 01726 813979 or email us at hello@ninegrp.com — we're happy to help!

TTS Velook System Micro Blue Flat Mop

Microfibre flat mop, highly absorbent, with Velook System support. Flat mopping system with frame with Velook System, to be used either pre-soaked, soaked on demand with soaking station or with handles with tank. Ideal for recurring washing of smooth surfaces.

Compatible Frame - See page 43



- **Features:**
- – Easy: mop changing is easy and quick
- – Ergonomic: it is the most lightweight system of TTS range
- – Highest hygiene: microfibre penetrates into the microporosity of the floor, collecting dirt and more than 95% of bacteria
- – Long durability: high quality strap tape to ensure a long life of the mop

TTS - Velook System Micro Blue Flat Mop, Light Blue

Removable colour coded tabs

SKU:

Size:

NG	12040235-02	40cm
NHSSC	MKB85300	

TTS Velook System Micro Red Flat Mop

Microfibre flat mop, highly absorbent, with Velook System support. Flat mopping system with frame with Velook System, to be used either pre-soaked, soaked on demand with soaking station or with handles with tank. Ideal for recurring washing of smooth surfaces.

Compatible Frame - See page 43



- **Features:**
- – Easy: mop changing is easy and quick
- – Ergonomic: it is the most lightweight system of TTS range
- – Highest hygiene: microfibre penetrates into the microporosity of the floor, collecting dirt and bacteria
- – Long durability: high quality strap tape to ensure a long life of the mop

TTS - Velook System Micro Red Flat Mop, Red

Removable colour coded tabs

SKU:

Size:

NG	12040235-01	40cm
NHSSC	MKB85227	

TTS Velook System Microriccio Flat Mop

Microfibre flat mop looped end with Velook System support. Flat mopping system with frame with Velook System, to be used either pre-soaked, soaked on demand with soaking station or with handles with tank. Ideal for any surface and for particle dirt thanks to the high dirt collection power of yarn and microfibre.

Compatible Frame - See page 43



- **Features:**
- – Easy: mop changing is easy and quick
- – Ergonomic: it is the most lightweight system of TTS range
- – Highest hygiene: microfibre penetrates into the microporosity of the floor, collecting dirt and more than 95% of bacteria
- – Long durability: high quality strap tape to ensure a long life of the mop

TTS – Velook System Microriccio Flat Mop, Blue

SKU:		Size:
NG	12040232-02	40cm
NHSSC	MKB85222	

TTS – Velook System Microriccio Flat Mop, Green

SKU:		Size:
NG	12040232-03	40cm
NHSSC	MKB85283	

TTS – Velook System Microriccio Flat Mop, Red

SKU:		Size:
NG	12040232-01	40cm
NHSSC	MKB85301	

TTS – Velook System Microriccio Flat Mop, White

SKU:		Size:
NG	12040232-12	40cm
NHSSC	MKB85268	

TTS – Velook System Microriccio Flat Mop, Yellow

SKU:		Size:
NG	12040232-04	40cm
NHSSC	MKB85242	

TTS Velook System Soft Band Flat Mop with Border

White microfibre flat mop with blue stripes, intensive action, with Velook System support and shockproof reinforced border. Flat mopping system with frame with Velook System, to be used either pre-soaked, soaked on demand with soaking station or with handles with tank. Ideal for smooth or porous interior floors with greasy dirt.

Compatible Frame - See page 43

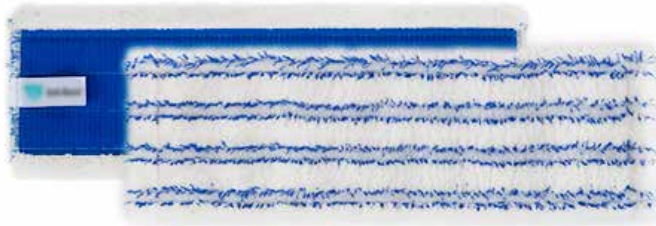

Features:

- Easy: mop changing is easy and quick
- Ergonomic: it is the most lightweight system of TTS range
- Highest hygiene: microfibre penetrates into the microporosity of the floor, collecting dirt and more than 95% of bacteria
- Effective: excellent intensive degreasing action of polyester on dirt without damaging surfaces
- Long durability: high quality strap tape to ensure a long life of the mop

TTS - Velook System Soft Band Flat Mop, White/Blue Stripes

Removable colour coded tabs

SKU:

Size:

NG	12040237-12	40cm
NHSSC	MKB85269	

TTS Velook System Soft Striat Flat Mop

White microfibre flat mop with blue stripes, intensive action, with Velook System support and shockproof reinforced border. Flat mopping system with frame with Velook System, to be used either pre-soaked, soaked on demand with soaking station or with handles with tank. Ideal for smooth or porous interior floors with greasy dirt.

Compatible Frame - See page 43

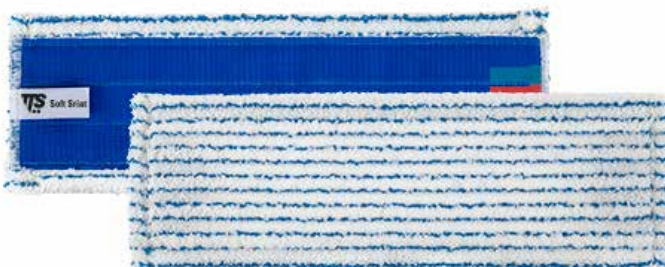

Features:

- Easy: mop changing is easy and quick
- Ergonomic: it is the most lightweight system of TTS range
- Highest hygiene: microfibre penetrates into the microporosity of the floor, collecting dirt and more than 95% of bacteria
- Long durability: high quality strap tape to ensure a long life of the mop

TTS - Velook System Soft Striat Flat Mop, White/Blue Stripes

Removable colour coded tabs

SKU:

Size:

NG	12040238-12	40cm
NHSSC	MKB85299	

TTS Velook System Tris Flat Mop

White microfibre flat mop with blue stripes and reinforced shockproof border, compatible with Velook System frames. Can be used pre-soaked, on-demand with a soaking station, or with tank handles. Three-fibre design—cotton for absorption, microfibre for dirt collection, and polyester for grease and low friction—makes it effective on all surfaces and types of dirt.

Compatible Frame - See page 43



• **Features:**

- — Easy: mop changing is easy and quick
- — Ergonomic: it is the most lightweight system of TTS range
- — Multipurpose: the combination of different fibres allows making many operations with one single mop
- — Highest hygiene: microfibre penetrates into the microporosity of the floor, collecting dirt and more than 95% of bacteria
- — Long durability: high quality strap tape to ensure a long life of the mop

TTS - Velook System Tris Flat Mop

Removable colour coded tabs

SKU:	Size:
NG 12040234-12	40cm
NHSSC MKB85239	

TTS Velook System Ultrasafe Flat Mop

Microfibre and polypropylene flat mop for R10/11 non-slip surfaces, with Velook System support. Flat mopping system with frame with Velook System, to be used either pre-soaked, soaked on demand with soaking station or with handles with tank. Ideal for washing of non-slip or porous surfaces, suitable to remove ingrained dirt.

Compatible Frame - See page 43



• **Features:**

- — Easy: mop changing is easy and quick
- — Ergonomic: it is the most lightweight system of TTS range
- — Effective: the abrasive action of polypropylene removes dirt easily
- — Highest hygiene: microfibre penetrates into the microporosity of the floor, collecting dirt and more than 95% of bacteria
- — Very low friction: glides effortlessly on non-slip surfaces

TTS - Velook System Ultrasafe Flat Mop, Blue

Removable colour coded tabs

SKU:	Size:
NG 12040236-02	40cm
NHSSC MKB85290	



TTS - Velook System Ultrasafe Flat Mop, Red

Removable colour coded tabs

SKU:	Size:
NG 12040236-01	40cm
NHSSC MKB85284	

TTS Dosely [Fluid Tank – EPDM Seals]

Dosing device for on-demand mop soaking, including one adhesive labels set (1 red + 1 blue).

Soaking station for single mop soaking directly on the trolley. Ideal for any environment that wants the benefits of pre-soaking without the burden of management.

Compatible Trolleys - See pages 20 to 28

Features:

- Multipurpose: designed to manage two different degrees of risk and relative detergents
- Total control: reduces subjectivity of the operator allowing total control of the dosage
- Effective: the cleaning solution is protected in a hermetic tank that keeps intact the active ingredients of the chemical
- Versatile: allows you to adapt the moistness of the mop to the size of the area to be cleaned and the type of floor
- Intuitive: designed highlighting areas of interaction to reduce training time
- Mechanic: it does not contain electrical parts, minimizing consumption, maintenance and environmental impact during disposal



TTS – Dosely, Soak Mops/Cloths On Demand, 1x 6L Fluid Tank [EPDM Seals]

SKU:	Size:
NG 12040540-01 NHSSC MKB85266	56x28x56cm



TTS – Double Dosely, Soak Mops/ Cloths On Demand, 2x 6L Fluid Tank [EPDM Seals]

SKU:	Size:
NG 12040540-02 NHSSC MKB85233	56x28x56cm

TTS Pockety System

Pockety is a professional cleaning system designed to enable completely touch-free unhooking and disposal of used mops and cloths. It aims to boost hygiene, reduce operator contact with dirt and contaminants, and streamline the cleaning workflow in busy environments.

Compatible Multipurpose Trolleys - See pages 20 to 28



- Features:**
- Touch-free cleaning system built for healthcare.
 - Eliminate hand contact, boost hygiene, and save time.
 - Designed to meet hospital-grade infection control standards.

TTS Structure

Wheel [ø 80 mm]
SKU:

NG **12040595-02**
NHSSC

Wheelless
SKU:

NG **12040595-01**
NHSSC



TTS Lid

SKU: Size:

NG 12040539	55x23x12cm
NHSSC	



TTS 20L Rectangular Bucket

Red
SKU: Size:

NG 12040532-01	26x58x27cm
NHSSC	

Blue
SKU: Size:

NG 12040532-02	26x58x27cm
NHSSC	



TTS 35L Collection Bag with String

Red

SKU:	Size:
NG 12040678-01 NHSSC	65x46cm

Blue

SKU:	Size:
NG 12040678-02 NHSSC	65x46cm



TTS Pockety Lampo Frame

SKU:	Size:
NG 12040417 NHSSC	40cm x 11cm

TTS Pockety Frame - Block System

SKU:	Size:
NG 12040416 NHSSC	40cm x 11cm

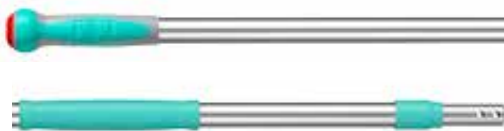

TTS Handle [Aluminium or Telescopic]

Compatible Handles - See pages 37 & 38

Disposable Mop Head Screw On [87g]

A lightweight, super-absorbent and semi-disposable mop made by recycling offcuts of a spunlace fabric. Features a more environmentally socket with less plastic.

Handles - See pages 34 & 35
Adapter - See page 35

- Features:**
- Fast-drying
 - Low-linting alternative to cotton mops
 - Colour coded to help minimise cross contamination
 - Made in UK
 - Screw Fit



Disposable Mop Head - Screw On Red - 87g

SKU:	Qty:
NG 11040402-01 NHSSC	10



Disposable Mop Head - Screw On Blue - 87g

SKU:	Qty:
NG 11040402-02 NHSSC	10



Disposable Mop Head - Screw On Green - 87g

SKU:	Qty:
NG 11040402-03 NHSSC	10



Disposable Mop Head - Screw On Yellow - 87g

SKU:	Qty:
NG 11040402-04 NHSSC	10



Disposable Mop Head - Screw On White - 87g

SKU:	Qty:
NG 11040402-05 NHSSC	10

Washable Mop Head Screw On [250g]

A hard wearing mop made from a unique blend of bleached cotton and synthetic yarns. The stayflat band holds the shape enabling the mop to cover a larger floor area. With looped end yarn prevents linting and tangling.

Handles - See pages 34 & 35
Adapter - See page 35

- Features:**
- Made from recycled polyester and cotton yarns
 - Features TID socket
 - Available in various weights and colour coded
 - Washable up to 60 degrees.
 - Made in UK.
 - Screw Fit



Washable Mop Head - Screw On Red - 250g

SKU:	Qty:
NG HY923022R NHSSC	10



Washable Mop Head - Screw On Blue - 250g

SKU:	Qty:
NG HY923022B NHSSC	10



Washable Mop Head - Screw On Green - 250g

SKU:	Qty:
NG HY923022G NHSSC	10



Washable Mop Head - Screw On Yellow - 250g

SKU:	Qty:
NG HY923022Y NHSSC	10

Mop Head Socket Standard [120g]

A lightweight, super-absorbent and semi-disposable mop made by recycling offcuts of a spunlace fabric. Features a more environmentally socket with less plastic.

Handles - See pages 36

- Features:**
- Fast-drying
 - Low-linting alternative to cotton mops
 - Ideal for smaller areas
 - Colour coded to help minimise cross contamination
 - Made in UK
 - Push Fit



Mop Head - Socket - Red - 120g

SKU:	Qty:
NG HY923010R NHSSC	10



Mop Head - Socket - Blue - 120g

SKU:	Qty:
NG HY923010B NHSSC	10



Mop Head - Socket - Green - 120g

SKU:	Qty:
NG HY923010G NHSSC	10



Mop Head - Socket - Yellow - 120g

SKU:	Qty:
NG HY923010Y NHSSC	10



Mop Head - Socket - White - 120g

SKU:	Qty:
NG HY923010W NHSSC	10

Nine Group – Disposable Microfibre Flat Pocket Mop – Pack of 25

Disposable microfibre cloths for pocket style mopping systems. Compatible with pre soaked use, on demand soaking stations, or tank equipped handles. Perfect for high contamination environments.

Compatible Frame – See pages 39 to 40, 46 & 65

Features:

- Eliminates 99.99 per cent of germs, including coronaviruses
- Designed for single use to reduce risk of cross contamination
- Uses minimal water and cleaning agents
- Strong and durable
- Easily identified through colour coding



Nine Group Disposable Microfibre Flat Pocket Mop – Pack of 25 – Red

SKU:

Size:

NG	11040526-01	40cm x 13cm
NHSSC	MKD85819	



Nine Group Disposable Microfibre Flat Pocket Mop – Pack of 25 – Blue

SKU:

Size:

NG	11040526-02	40cm x 13cm
NHSSC	MKD85825	



Nine Group Disposable Microfibre Flat Pocket Mop – Pack of 25 – Green

SKU:

Size:

NG	11040526-03	40cm x 13cm
NHSSC	MKD85824	



Nine Group Disposable Microfibre Flat Pocket Mop – Pack of 25 – Yellow

SKU:

Size:

NG	11040526-04	40cm x 13cm
NHSSC	MKD85817	

TTS – Exon Disposable Microfibre Flat Pocket Mop – Pack of 35

Semi-disposable microfibre cloth for pocket system, packed. Flat mopping system with pockets, to be used either pre-soaked, soaked on demand with soaking station or with handles with tank. Ideal for environments with high risk contamination

Compatible Frame – See pages 39 to 40, 46 & 65



- Features:**
- Semi-disposable: either disposable or washable up to 10 times
 - Highest hygiene: microfibre penetrates into the microporosity of the floor, collecting dirt and more than 95% of bacteria
 - Easy: mop changing is easy and quickly
 - Washable – max temperature 60° C

TTS Exon Disposable Microfibre Flat Pocket Mop – Pack of 35

SKU:	Size:
NG 11040522 NHSSC MKD85826	40cm x 13cm

Wet2Go Disposable Multi Mop

With our Multi mop one can clean a floor of about 20m2 with just one mop. It is hygienic (no cross contamination), time-saving and easy. Due to the microfibre based open structure of the cleaning layer, the dirt gets soaked up into the mop and the surface remains clean and streak free. The advanced barrier film creates a hygienic barricade between the dirt and the frame to which the mop is attached.

Compatible Frame – See page 43



- Features:**
- Removes >99% of microorganisms with the use of only water (certified according EN 16615:2015)
 - Convenient (no washing, easy preparation, less logistics)
 - Constant performance (each time new mop)
 - 13 gram = 20m2 cleaning
 - Money-saving (lightweight mop, no washing costs, less transport)
 - Eco-friendly (no washing, less transport)
 - No detergent required

Wet2Go Disposable Multi Mop – 42x13cm – Pack of 20

SKU:	Qty:
NG 11040464-05 NHSSC MKB85241	Pack of 20

Wet2Go Disposable Disinfect Mop

In disinfection, preventing cross-contamination is crucial. Our disposable disinfect mops are designed to capture bacteria and viruses within the mop. These are then disposed of, which effectively reduces the risk of cross-contamination to zero. Thanks to the advanced and highly absorbent layer, one disposable mop can cover approximately 30m²

Compatible Frame - See page 43



Features:

- Absorption >180ml which equals > 30m² capacity per mop
- Convenient (no washing, easy preparation, less logistics)
- Slow discharge of the liquid
- Hygienic and constant performance (each time new mop)
- Money-saving (no washing costs, less transport)
- Eco-friendly (no washing, less transport)

Wet2Go Disposable Disinfect Mop - 42x13cm - Pack of 5

SKU:

Qty:

NG **11040465-05**
NHSSC **MKB85275**

Pack of 5

Wet2Go Disposable Spill Absorbing Mop

Cleaning large pools of liquid can be challenging because accidents often happen when cleaning staff aren't around. The design of the mop makes it convenient because you can easily dispose of both the mop and the captured dirt after use. This reduces the risk of cross-contamination almost entirely. By using a new mop for each spill, you ensure a hygienic and consistent performance with every cleaning task.

Compatible Frame - See page 43



Features:

- Absorption >250ml per mop
- Convenient (no washing, easy preparation, less logistics)
- Hygienic and constant performance (each time new mop)
- Money-saving (no washing costs, less transport)
- Eco-friendly (no washing, less transport)

Wet2Go Disposable Spill Absorbing Mop - 42x13cm - Pack of 5

SKU:

Qty:

NG **11040466-05**
NHSSC **MKB85282**

Pack of 5

Wet2Go Dry Dust Bio Based Impregnated Sweeping Cloth

This compostable dust cloth is perfect for dust and dirt removal. Vegatex is impregnated with bio-based impregnation liquid. Sustainability and disposability can get along perfectly. 100% plastic-free, and home compostable. Still keeping its amazing ability to collect dust.

Compatible Frame - See pages 43, 173 & 174



- Features:**
- 100% bio-based materials
 - Vegan impregnation liquid
 - 100% plastic-free
 - Home compostable packaging (TUV certified)
 - Very effective cleaning

Wet2Go Dry Dust Bio Based Impregnated Sweeping Cloths - 60x24cm - Pack of 25

SKU:	Qty:
NG 11040468	Pack of 25
NHSSC MKC85379	

Wet2Go Ready Care Disposable Pre-Soaked Flat Mop

The state-of-the-art cleaning wipe for professional usage. Cleaning has never been easier, faster, and more professional. This pre-wetted solution can be instantly used. Bulkier than most other disposable wipes, the Ready cloth is very comfortable to hold and has a great hand touch. Due to the unique composition the WET2GO Ready cloth does not leave any residue on surfaces, the liquid decomposes in just water and oxygen, which are both not harmful for the environment.

Compatible Frame - See page 43



- Features:**
- 100% convenient (no washing, no preparation, less logistics)
 - Ready to use = failure free
 - Maximum dirt removal: 99.9% microorganism removal
 - Up to 40% time saving compared to traditional mops
 - 1 mop can be used to clean 20m2
 - Zero residue cleaning, 100% biodegradable cleaning liquid
 - Eco-friendly (no washing, less transport, reduced waste water disposal)
 - Money-saving (less labour, no washing costs, less transport)
 - State of the art dispenser packaging

Wet2Go Ready Care Disposable Pre-Soaked Flat Mop - 42x13cm - Pack of 12

SKU:	Qty:
NG 11040461-05	Pack of 12
NHSSC MKB85240	

Wet2Go Ready ProGen Disposable Pre-Soaked Flat Mop

4-layer disposable cleaning mop with microfibres to clean ± 20m². Due to the open structure of the cleaning layer, the dirt is absorbed into the absorption layer. The advanced fixing layer (barrier foil) prevents the frame from contamination. Ready to use can be used immediately, anywhere!

Compatible Frame - See page 43



- Features:**
- 100% convenient (no washing, no preparation, less logistics)
 - Up to 40% time saving compared to traditional mops
 - Excellent for easy cleaning of small areas
 - State of the art dispenser packaging
 - Excellent cleaning performance
 - Eco-friendly (no washing, less transport, reduced waste water disposal)
 - Money-saving (less labour, no washing costs, less transport)

Wet2Go Ready ProGen Disposable Pre-Soaked Flat Mop - 42x13cm - Pack of 12

SKU:	Qty:
NG 11040462-05 NHSSC MKB85265	Pack of 12



Simple & Easy Suitable for all body fluids

- ✓ **Non Chlorine**
- ✓ **Odour-free**
- ✓ **Non-Toxic**

Medi9 Universal Spill Pad Kit
NG: 18041216 / NHSSC: MKO85182

See page 194



Buckets

TTS 10L Hermetic Bucket & Lid

Bucket with hermetic lid and handle. Hermetic bucket for pre-soaking and transport of mops. Ideal to transport and pre-soak 40-50cm floor mops.

- Features:**
- Handy: the cross handle facilitates transport and emptying
 - Hermetic: the lid hook system and a special gasket ensure an airtight seal



TTS - 10L Hermetic Bucket Red & Lid

SKU:		Size:
NG	12040530-01	10L
NHSSC	MKO85246	



TTS - 10L Hermetic Bucket Blue & Lid

SKU:		Size:
NG	12040530-02	10L
NHSSC	MKO85171	



TTS - 10L Hermetic Bucket Yellow & Lid

SKU:		Size:
NG	12040530-04	10L
NHSSC	MKO85159	



Spare Part / Accessory

TTS - 10/20L Hermetic Bucket Lid

SKU:

NG	12040530-01
NHSSC	MKO85246



TTS 20L Hermetic Bucket & Lid

Bucket with hermetic lid and handle. Hermetic bucket for pre-soaking and transport of mops. Ideal to transport and pre-soak 40-50cm floor mops.

- **Features:**
- – Handy: the cross handle facilitates transport and emptying
- – Hermetic: the lid hook system and a special gasket ensure an airtight seal
-
-
-
-
-



TTS - 20L Hermetic Bucket Red & Lid

SKU:		Size:
NG	12040531-01	20L
NHSSC	MKO85199	

TTS - 20L Hermetic Bucket Blue & Lid

SKU:		Size:
NG	12040531-02	20L
NHSSC	MKO85181	

TTS - 20L Hermetic Bucket Green & Lid

SKU:		Size:
NG	12040531-03	20L
NHSSC	MKO85166	

TTS - 20L Hermetic Bucket Grey & Lid

SKU:		Size:
NG	12040531-11	20L
NHSSC	MKO85241	



“

**Maurice Madeo,
Deputy Director Infection
Prevention and Control.**

NHS

**Northern Lincolnshire
and Goole**
NHS Foundation Trust

The decision was taken by NLAG to look at the cleaning processes & procedures [after] identifying that the trust was using significant quantities of chlorine-based disinfectants daily, and was of detriment to patients, staff, and the environment. Consultation with Facilities resulted in Nine Group being invited to present alternative products for evaluation.

NLAG was using a variety of different standard and chlorine-based cleaning products daily. Following a trial period, the decision was made to roll out Medi9 & Uni9 products across all three NLAG hospitals.

The usage of products [was] reduced by 50% ...and a reduction in the number of requests for deep cleans by nearly 15%.

The six months after implementation of Medi9 & Uni9 usage has produced positive feedback from patients and staff.

In addition, it has helped the Trust achieve a 30% reduction in the number of C.Difficile cases, [and] are pleased to report that we've not had to close an entire ward due to viral...outbreaks for twelve months.

”

TTS Pit 12L Mop Bucket & Wringer

Single mop bucket. Single mop bucket for squeezer.

Features:

- Ideal for a semi-professional use



TTS - Pit Mop bucket & wringer Red 12L

SKU:	Size:
NG 12040510-01 NHSSC MKB85296	12L



TTS - Pit Mop bucket & wringer Blue 12L

SKU:	Size:
NG 12040510-02 NHSSC MKB85225	12L



TTS - Pit Mop bucket & wringer Green 12L

SKU:	Size:
NG 12040510-03 NHSSC MKB85295	12L



TTS - Pit Mop bucket & wringer Yellow 12L

SKU:	Size:
NG 12040510-04 NHSSC MKB85247	12L

TTS Easy 14L Mop Bucket & Wringer

Single mop bucket. Single mop bucket for squeezer.

Features:

- Ideal for a semi-professional use



TTS - Easy Mop bucket & wringer Red 14L

SKU:	Size:
NG 12040511-01 NHSSC MKB85246	14L



TTS - Easy Mop bucket & wringer Blue 14L

SKU:	Size:
NG 12040511-02 NHSSC MKB85224	14L



TTS - Easy Mop bucket & wringer Green 14L

SKU:	Size:
NG 12040511-03 NHSSC MKB85229	14L



TTS - Easy Mop bucket & wringer Yellow 14L

SKU:	Size:
NG 12040511-04 NHSSC MKB85256	14L

TTS Uni Junior 14L Bucket & Wringer

Uni Junior 14L single bucket with wringer.

Frame - See page 43
Mop Head - See page 58

- **Features:**
- — Ideal for a semi-professional use
-
-



TTS - Uni Junior Bucket & Wringer, Red Handle, 14L

SKU:	Size:
NG 12040523-01	14L
NHSSC MKO85240	



TTS - Uni Junior Bucket & Wringer, Blue Handle, 14L

SKU:	Size:
NG 12040523-02	14L
NHSSC MKO85157	



TTS - Uni Junior Bucket & Wringer, Green Handle, 14L

SKU:	Size:
NG 12040523-03	14L
NHSSC MKO85165	



TTS - Uni Junior Bucket & Wringer, Yellow Handle, 14L

SKU:	Size:
NG 12040523-04	14L
NHSSC MKO85233	

TTS Replacement 15L Bucket with Handle

Single bucket with handle.

- **Features:**
- — Eco-friendly: completely made of polypropylene, non-rusting, solid and entirely recyclable
-
-



TTS - Replacement Bucket with Handle, Red 15L

SKU:	Size:
NG 12040520-01	15L
NHSSC MKO85222	



TTS - Replacement Bucket with Handle, Blue 15L

SKU:	Size:
NG 12040520-02	15L
NHSSC MKO85221	

TTS Single Nick Tec & 15L Bucket

Trolley with coloured structure and Tec wringer, blue bucket and 80° mm wheels with bumpers. Single cleaning trolley with professional jaw wringer. Ideal for cleaning medium-large areas where it is necessary to rinse the mop.
Compatible with flaps, Pocket System and mops.



Features:

- Shock-resistant: one-piece frame entirely made of plastic, guarantees lightness and strength and increased lifespan
- Long durability: wringer studied for a long life cycle of the product, best seller for TTS for more than 20 years
- Effective: wringer studied with a mechanism that brings jaws to the bottom ensuring performance without the need of reductions
- Large: equipped with basin to hold tools integrated into the frame
- Easy to assemble: without screws

TTS - Nick Tec Each, 15L on caddy frame with rear storage tray

SKU: _____ Size: _____

NG	12040516-02	15L
NHSSC	MKO85185	

TTS Single Nick Tec "U" Handle & 15L Bucket

Trolley with "U" handle, coloured structure and Tec wringer, blue bucket and 80° mm wheels with bumpers. Single cleaning trolley with professional jaw wringer. Ideal for cleaning medium-large areas where it is necessary to rinse the mop. Compatible with flaps, pocket system and mops.



Features:

- Shock-resistant: one-piece frame entirely made of plastic, guarantees lightness and strength and increased lifespan
- Long durability: wringer studied for a long life cycle of the product, best seller for TTS for more than 20 years
- Effective: wringer studied with a mechanism that brings jaws to the bottom ensuring performance without the need of reductions
- Large: equipped with basin to hold tools integrated into the frame
- Easy to assemble: without screws

TTS - Nick Tec Each, 15L with push handle, on caddy frame with rear storage tray

SKU: _____ Size: _____

NG	12040517-02	15L
NHSSC	MKO85237	

TTS Action Pro Tec & Double 30L Bucket Combo Mopping Unit

Double bucket with two drain-plugs and Tec wringer, plain coloured, 80° mm wheels. Professional jaw wringer. Ideal for cleaning medium-large areas where it is necessary to rinse the mop.
Compatible with flaps, pocket system and mops.

- Features:**
- Highest hygiene: rinsing water is always clean thanks to the back drain-plug that allows emptying the bucket when necessary
 - Effective: separation of cleaning solution from rinsing water allows a better cleaning result, less waste of water and chemical
 - Ergonomic: the drain-plugs allow emptying the bucket without lifting and higher than the traditional buckets to allow the operator to work while standing
 - Easy to maintain: the smooth surfaces and the absence of cavities facilitate cleaning and guarantee a high level of hygiene
 - Handy: double handle to carry it easily



TTS - Action Pro Tec Combo Mopping Unit Red 30L double bucket with Tec wringer.

SKU:		Size:	
NG	12040519-01		30L
NHSSC	MKB85287		



TTS - Action Pro Tec Combo Mopping Unit Blue 30L double bucket with Tec wringer.

SKU:		Size:	
NG	12040519-02		30L
NHSSC	MKB85292		



TTS - Action Pro Tec Combo Mopping Unit Green 30L double bucket with Tec wringer.

SKU:		Size:	
NG	12040519-03		30L
NHSSC	MKB85291		



TTS - Action Pro Tec Combo Mopping Unit Yellow 30L double bucket with Tec wringer.

SKU:		Size:	
NG	12040519-04		30L
NHSSC	MKB85260		

Hygiene Mop Bucket & Wringer 12L

A sturdy polypropylene bucket with a high profile clip on wringer to reduce spillage and aid efficiency.



- Features:**
- — Graduation marks, lowline pouring spout and base finger grips for easy pouring.
 - — Wringer features 3-point anchor supports, mop handle holder, high neck sieve, and overspill holes.
 - — Hardwearing and durable plastic.
 - — Suitable for mops up to 250g.
 - — Made in UK.
 - — 70% recycled plastic option in black now available.

Hygiene Mop Bucket & Wringer - 12L - Yellow

SKU:		Size:
NG	12040512-04	12L
NHSSC	MKB85257	



...does exactly
what it says
on the label!

Uni9 Air Freshener Trigger Spray - 750ml
NG **19041034** / NHSSC **MKJ85465**

See page 95

TTS 4L Bucket with Wipe Dispensing Lid

Bucket with handle and hermetic lid for disposable soaked cloths. Rectangular bucket, conceived to be used with manual cloths. Ideal to be used with pre-cut roll cloths.

Compatible Refill Packs - See pages 124 & 152

- Features:**
- Efficient: ensures quick soaking of the mops
 - Effective: the hermetic lid closure preserves its active principles
 - Handy: the closable window facilitates the extraction of the individual tears



TTS - Bucket with Wipe Dispensing Lid - 4L - Red

SKU:	Size:
NG 12040616-01 NHSSC MKD85815	4L



TTS - Bucket with Wipe Dispensing Lid - 4L - Blue

SKU:	Size:
NG 12040616-02 NHSSC MKD85818	4L



TTS - Bucket with Wipe Dispensing Lid - 4L - Green

SKU:	Size:
NG 12040616-01 NHSSC MKD85820	4L



TTS - Bucket with Wipe Dispensing Lid - 4L - Yellow

SKU:	Size:
NG 12040616-04 NHSSC MKD85821	4L

TTS Lampo System

www.ninegrp.com/tts-handles-and-frames

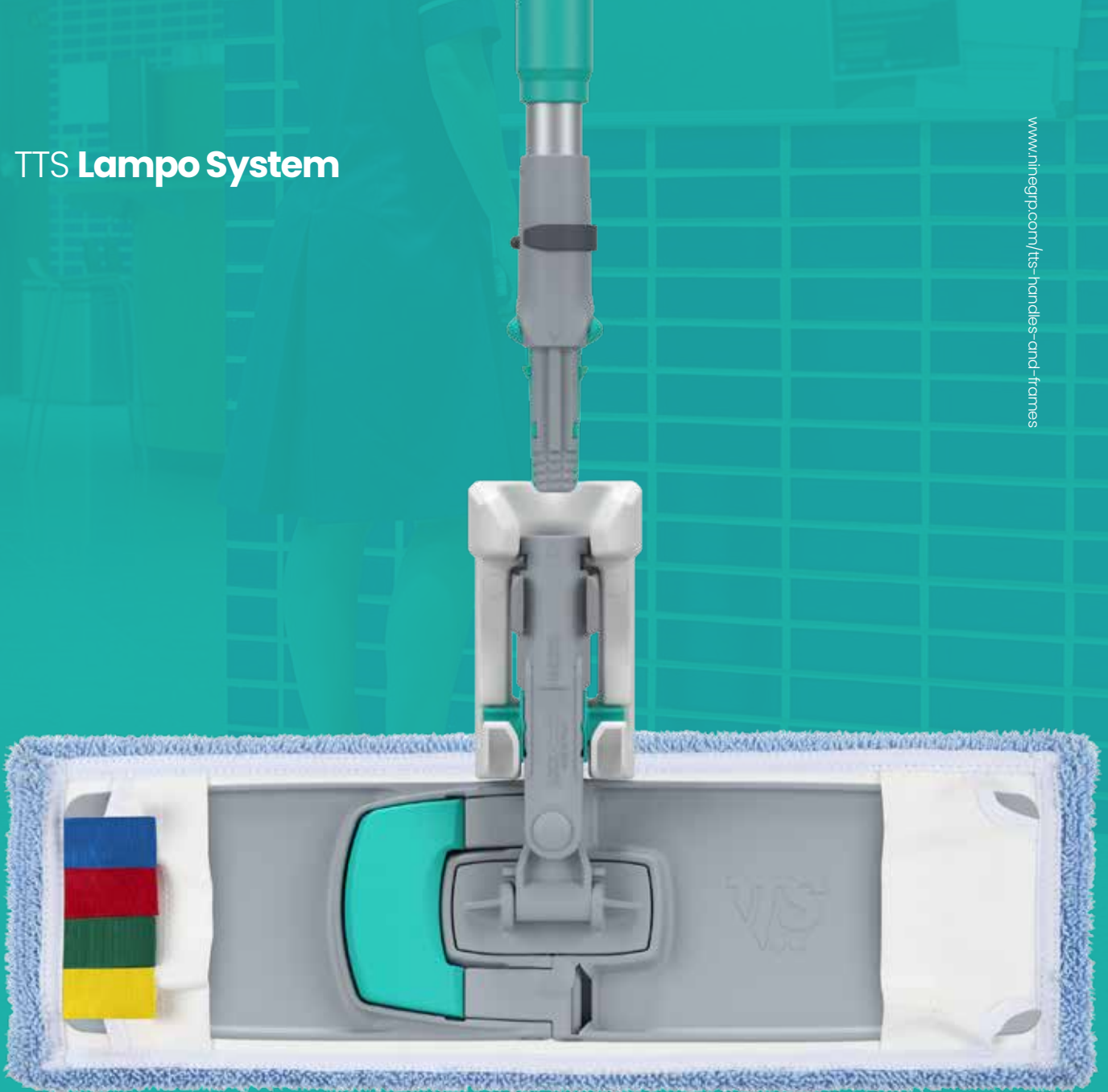

Instant tool attachment Enhanced safety Universal compatibility



Have a question and would like a virtual demo?

We can do that, schedule a time that works for you and we'll explore solutions together.

www.ninegrp.com/livedemo

Call us

01726

813979





Chemicals

Uni9 Air Freshener

Instant Freshness

Uni9 Air Freshener is lemon scented for that fresh citrus smell. A powerful universally accepted lemon fragrance provides long-lasting results. Uni9 Air Freshener enhances the environment in any establishment or vehicle, when sprayed into the corners of rooms, enclosures, directly onto flooring and open spaces.



Uni9 Air Freshener
Trigger Spray - 750ml

SKU:	Size:
NG 19041034 NHSSC MKJ85465	750ml

- Features:**
- Fast & effective
 - Biodegradable
 - Quickly freshens an area
 - Can be used in almost any area

Air Freshener Aerosol 300ml – Linen Fresh

Water based Air Freshener



Air Freshener Aerosol
300ml – Linen Fresh

SKU:	Size:
NG 11041491-01 NHSSC MKJ85469	300ml

- Features:**
- 300ml
 - Fresh Linen scent

Air Freshener [Concentrate] 2L

Concentrated lemon air freshener for use after dilution



Air Freshener
Concentrated – 2L

SKU:	Size:
NG 11041490 NHSSC MKJ85471	2L

- Features:**
- Lemon perfume in a slow release
 - Long-lasting results

1 No.

Choice for cleaning faster and disinfecting smarter.

Versatile cleaning & disinfecting product engineered to maintain superior hygiene - **See pages 96 to 97 & 153**



Multi-Formats



Complies



Sensitive



Removes



Fast



Made in Britain

Chlorine Releasing Tablets 300 Per Tub

Chlorine tablets for rapid disinfection.



Chlorine Releasing
Tablets - 300 Per Tub

SKU:		Qty
NG	13040037	Tub of
NHSSC	MKJ85467	300

Features:

- Prolonged shelf life
- For rapid bleaching and disinfection

Cream Cleaner 1L

Cream Cleaner removes built up grease and grime, including burnt on food. The powerful formula is tough on stains, gentle on surfaces.



Cream Cleaner
1L (2 x 500ml)

SKU:		Size:
NG	11040552-01	2x
NHSSC	MKJ85466	500ml

Features:

- Cleans & deodorises
- Non scratch
- Pleasant fragrance

Dishwasher Salt 10kgs

The No.1 granular salt for water softening in the UK Granulite granular salt is a unique water softening salt produced by a special evaporation process, which forms rounded beads of salt from single crystals.



Dishwasher Salt - 10kgs

SKU:		Size:
NG	11040562-10	10kgs
NHSSC	MKK85189	

Features:

- Easy flowing
- High purity



Professional Dishwasher Powder 5kg

Tricel professional dishwasher powder. For use on crockery, cutlery and glassware. Loosens and disperses grease and protein to deliver stunning results.

- **Features:**
- – Biodegradable



Professional Dishwasher Powder - 5kg Bucket

SKU:	Size
NG 11040622-05 NHSSC MKK85188	5kg

General Purpose Washing Up Liquid 500ml

Thick washing up liquid with superb grease removal leaves a sparkling finish

- **Features:**
- – Effective washing up liquid
 - – Cuts through food and grease stains
 - – Ideal for use in kitchens and canteens
 - – Original scent



General Purpose Washing Up Liquid - 500ml

SKU:	Size:
NG 11040672-07 NHSSC MKJ85478	500ml

Premium Washing Up Liquid 1L

A versatile concentrated pH neutral washing up liquid with a fresh citrus fragrance. Ideal for general cleaning tasks.



Premium Washing Up Liquid - 1L

SKU:	Size:
NG 11040672-01	1L
NHSSC MKJ85480	

Features:

- High performance formulation
- Fresh citrus fragrance
- Cuts through grease

Hard Surface Food Safe Anti-Bacterial Cleaner Concentrate 5L

Super Food Safe Anti-bacterial Sanitiser's powerful formula kills 99.99% of germs, passing BS EN 1276 standards in 30 seconds. Also passes BS EN 13697. It is safe for a wide variety of applications and will not taint food contact surfaces.



Hard Surface Food Safe Anti-Bacterial Cleaner Concentrate - 5L

SKU:	Size:
NG 11040612-05	5L
NHSSC MKJ85479	

Features:

- Passes BS EN 1276, BS EN 13697
- Kills 99.99% of germs, including MRSA
- Works in 30 seconds
- Non tainting
- Non bleach formula

Professional Floor Cleaner & Maintainer 5L

Super Floor Maintainer is an important part of the floor maintenance system. Used regularly it removes grease, scuff marks and grime while maintaining the polish to keep the floors shining in between full renovation.



Professional Floor Cleaner & Maintainer - 5L

SKU:	Size:
NG 11040722-05	5L
NHSSC MKM85036	

Features:

- Regular use extends floor life
- Gentle cleaning
- Removes scuff marks and grime



Have a question and would like a virtual demo?

We can do that, schedule a time that works for you and we'll explore solutions together.

www.ninegrp.com/livedemo or call **01726 813919**



SCAN TO BOOK

Uni9 Fast & Effective Floor & Hard Surface Cleaner

Uni9’s Floor & Hard Surface Cleaner has a wide range of cleaning qualities, meaning that it can be used on a wide range of hard surfaces to give an excellent finish from either buffing or mopping.

Our Floor & Hard Surface Cleaner completes a number of tasks with one process, it will clean, deodorise and kill bacteria in one application. It has been produced fragrance-free or with a pleasant lemon aroma to complement the finished area. With a dilution rate of 1:15, Uni9’s Floor & Hard Surface Cleaner is not only an efficient hard surface cleaner but also a cost effective solution for all hard surface cleaning applications. Suitable for auto dosing systems.

Features:

- Antibacterial properties
- Cleans, disinfects and deodorises in one application
- Water rinsable
- Chlorine free



Uni9 Hard Surface Floor Cleaner Concentrate - Lemon 20L

SKU:	Size:
NG 19041017 NHSSC	20L



Uni9 Hard Surface Floor Cleaner Concentrate - Lemon 5L

SKU:	Size:
NG 19041015 NHSSC MKM85035	5L



Uni9 Hard Surface Floor Cleaner Concentrate - Lemon 1L in Dosing Bottle

SKU:	Size:
NG 19041013 NHSSC MKM85037	1L (Auto Dose Bottle)



Uni9 Floor/Hard Surface Cleaner Labelled Heavy Duty Trigger Spray Bottle - Yellow Trigger [Empty]

SKU:	Size:
NG 12040644-04 NHSSC MKJ85790	750ml

Uni9 Glass Cleaner

Instant Clear

Uni9's Universal Instant Clear Glass Cleaner will leave your glass, chrome and mirrors instantly sparkling due to its ability to dry quickly. It is also safe to use on all ceramic and stainless steel.

- Features:**
- Powerful cleaning
 - Water rinsable
 - Chlorine free
 - Biodegradable



Uni9 Glass Cleaner
Instant Clear - 750ml

SKU:	Size:
NG 19041040 NHSSC MKJ85473	750ml

Uni9 Odour Neutraliser

Instant Freshness

Uni9 Odour Neutraliser is a specialist cleaning product for neutralising and deodorising urine stains on carpet, upholstery, hard surfaces and to spray into the environment. Can be used on faeces and vomit stains. This product actually breaks down the crystallised body fluids, leaving them in suspension to be wiped or extracted away. Can be used on all water washable surfaces.

- Features:**
- Powerful odour elimination
 - Biodegradable
 - Quick & easy to apply
 - Leaves areas smelling refreshed



Fast & Effective Odour
Neutraliser Instant
Freshness

SKU:	Size:
NG UN921038 NHSSC	750ml

Uni9 Clean & Disinfect Multi Purpose Cleaner

Uni9's Multi Purpose Cleaner is a remarkable cleaning product, acting as a powerful bactericidal cleaner, degreaser, disinfectant and deodoriser in one single action.

Our Cleaner has industrial strength cleaning power, digging out tough grease and grime. It's an exceptional 'all-in-one product' for all types of maintenance, deep cleaning and disinfection - killing all known germs including MRSA, E.Coli, Salmonella, Pseudomonas, Staphylococcus, Enterococcus, Listeria, Legionella & many others.

Successfully removes and cleans silicone, sealant, paint, adhesive, bitumen, oil, grease, inks, expanding foam, body fluids, road film, stains, vinyls, plastics, chrome, engines, fibreglass, rubber, synthetic fabrics, plaster, enamel, tools, stainless steel and fungi. Some surfaces are inherently sensitive to alkaline cleaners; always test on an inconspicuous area first. Do not use on wool, leather or weathered surfaces.

- Features:**
- Powerful odour elimination
 - Biodegradable
 - Quick & easy to apply
 - Leaves areas smelling refreshed

Deconcentrate



Uni9 Multi Purpose Cleaner Solution 20L

SKU:	Size:
NG 19041084-20	20L
NHSSC MKJ85781	



Uni9 Multipurpose Cleaner Spray 750ml

SKU:	Size:
NG 19041082-07	750ml
NHSSC MKJ85793	



Uni9 Multi Purpose Cleaner Solution 5L

SKU:	Size:
NG 19041084-05	5L
NHSSC MKJ85476	



Uni9 Multi Purpose Cleaner Solution 1L

SKU:	Size:
NG 19041084-01	1L
NHSSC MKJ85475	

Concentrate



Uni9 Multi Purpose
Cleaner Concentrate 20L

SKU:	Size:
NG 19041080-20 NHSSC MKJ85791	20L



Uni9 Multipurpose
Cleaner Concentrate 5L

SKU:	Size:
NG 19041080-05 NHSSC MKJ85779	5L

Heavy Duty Spray Bottle 750ml [Empty]



Uni9 Multi Purpose Cleaner
Labelled Heavy Duty Trigger
Spray Bottle - Red Trigger
[Empty]

SKU:	Size:
NG 12040644-01 NHSSC MKJ85788	750ml



Looking for high
level disinfectant
wipe... Look at our
Medi9 range

**One Wipe.
Total Protection.**

See pages 113 to 125

Laundry Detergent Bio Pods

Box of 100

Laundry Capsules enriched with protective minerals, helps to keep laundry clean and tidy, by removing stains and keeping your clothes smelling fresh.



Laundry Detergent
Bio Pods – Box of 100

SKU:	Qty:
NG 11040646	Box of
NHSSC MLW85088	100

- Features:**
- Effective against stains
 - 100 x 13gm capsules

Laundry Detergent Non-Bio Pods

Box of 100

Laundry Capsules enriched with protective minerals, helps to keep laundry clean and tidy, by removing stains and keeping your clothes smelling fresh.



Laundry Detergent
Non-Bio Pods – Box of 100

SKU:	Qty:
NG 11040647	Box of
NHSSC MLW85085	100

- Features:**
- Non-Biological formula
 - For sensitive skin
 - Effective against stains
 - 100 x 13gm capsules

Laundry Powder – Bio with Lemon Fresh

10kgs/135 Washes

For optimum levels of whiteness and brightness, specially formulated for low lather.



Laundry Powder –
Bio with Lemon Fresh
10kgs [135 washes]

SKU:	Size:
NG 11040642-10	10kg
NHSSC MLW85087	

- Features:**
- Up to 135 washes per box
 - Contains enzymes
 - Lemon fresh fragrance
 - Ideal for use in front loading automatic machines

Laundry Powder – Non-Bio with Aloe Vera

10kgs/135 Washes

For optimum levels of whiteness and brightness, specially formulated for low lather



Laundry Powder –
Non-Bio with Aloe Vera
10kgs [135 washes]

SKU:

Size:

NG	11040644-10	10kg
NHSSC	MLW85084	

Features:

- Up to 135 washes per box
- Aloe Vera fragrance
- Ideal for use in front loading automatic machines

Professional Laundry Powder – Bio

6.8kgs/154 Washes

Biological Laundry Powder is a dermatologically tested laundry powder. A high quality biological powder formulated with technology that helps remove the most stubborn stains.



Professional Laundry
Powder – Bio
6.8kgs (154 washes)

SKU:

Size:

NG	11040642-06	6.8kg
NHSSC	MLW85083	

Features:

- Up to 154 washes per box
- Dermatologically tested
- Suitable for sensitive skin
- Tough on stains

Professional Laundry Powder – Non-Bio

6.8kgs/154 Washes

Non-Biological Laundry Powder is a dermatologically tested laundry powder suitable for sensitive skin. A high quality non-bio powder formulated with technology that helps remove the most stubborn stains.



Professional Laundry
Powder – Bio
6.8kgs (154 washes)

SKU:

Size:

NG	11040644-06	6.8kg
NHSSC	MLW85086	

Features:

- Up to 154 washes per box
- Dermatologically tested
- Suitable for sensitive skin
- Tough on stains

The perfect solutions for hand hygiene...



Uni9 Alcohol Hand Sanitiser

Uni9's Universal Alcohol Hand Sanitiser has been specifically formulated to kill harmful germs, viruses and bacteria in seconds - leaving hands safely disinfected and biologically clean.

Features:

- Using top grade ingredients reduces sticky residue
- Enhanced with Aloe Vera additive to reduce drying out of skin
- Foaming dispense more economical in use
- Additional packaging formats can be considered upon repeat
- Medical Grade, ≥ 70% Alcohol



Uni9 Alcohol Hand Sanitiser Hand Pump 600ml

SKU:	Size:
NG 19100032 NHSSC	600ml



Uni9 Alcohol Hand Sanitiser Hand Pump Foam 200ml

SKU:	Size:
NG 19100038 NHSSC	200ml



Uni9 Alcohol Hand Sanitiser Pocket Foam 50ml

SKU:	Size:
NG 19100030 NHSSC	50ml

Uni9 Alcohol Hand Sanitiser 750ml Refill

[Manual & Automatic Hand Dispenser]



Uni9 Alcohol Hand Wash
750ml Refill Dispenser Pouch

SKU:	Size:	
NG 19100034	750ml	
NHSSC	Pouch	

Uni9 Alcohol Hand Sanitiser

Manual & Automatic Hand Dispenser

Uni9 Hand Dispensers help provide to keep hands disinfected and biologically clean when on the move.

The dispensers are an excellent solution for public areas such as restaurants, bars, ballrooms and corridors.

Features:

- Manufactured from rugged and durable high quality plastics which can be easily recycled
- Simple and easy to install
- Easy to clean and wipe down
- Easy to reload
- Securely locked with key access



Uni9 Alcohol
Hand Wash
Manual Dispenser

SKU:	Product:	
NG 19104040	Manual Dispenser	
NHSSC		



Uni9 Alcohol
Hand Wash
Automatic Dispenser

SKU:	Product:	
NG 19104030	Manual Dispenser	
NHSSC		

Uni9 Cleansing Hand Wash

Uni9’s Antibacterial Cleansing Hand Wash has been specifically formulated to kill harmful germs, viruses and bacteria in seconds – leaving hands safely disinfected and biologically clean.

Uni9’s Cleansing Hand Wash is effective against viruses and bacteria – leaving hands safely disinfected and biologically clean.

A healthy & clean environment will prevent cross-contamination, control the spread of illness, reduce staff costs and improve the standard of care for staff, guests, patients and people in general.

Features:

- Foaming dispense more economical in use
- Additional packaging formats can be considered upon repeat
- Using high grade ingredients reduces sticky residue
- Rinsable
- Non-hazardous – safe for use in the vicinity of vulnerable people and children
- REACH and COSHH exempt
- Biodegradable



Uni9 Cleansing Hand Wash Hand Pump 600ml

SKU:	Size:
NG 19100044 NHSSC	600ml



Uni9 Cleansing Hand Wash Hand Pump 200ml

SKU:	Size:
NG 19100048 NHSSC	200ml



Uni9 Cleansing Hand Wash Pocket Hand Pump 50ml

SKU:	Size:
NG 19100040 NHSSC	50ml

Uni9 Cleansing Hand Wash 750ml Refill [Manual & Automatic Hand Dispenser]



Uni9 Cleansing Hand Wash 750ml Refill Dispenser Pouch

SKU:	Size:
NG 19100046 NHSSC	750ml Pouch

Uni9 Cleansing Hand Wash Manual & Automatic Hand Dispenser

Uni9 Hand Dispensers help provide to keep hands disinfected and biologically clean when on the move.

The dispensers are an excellent solution for public areas such as restaurants, bars, ballrooms and corridors.

Features:

- Manufactured from rugged and durable high quality plastics which can be easily recycled
- Simple and easy to install
- Easy to clean and wipe down
- Easy to reload
- Securely locked with key access



Uni9 Cleansing Hand Wash
Manual Dispenser

SKU:	Product:
NG 19104032 NHSSC	Manual Dispenser



Uni9 Cleansing Hand Wash
Automatic Dispenser

SKU:	Product:
NG UN904036W NHSSC	Manual Dispenser



Have a question? Call on 01726 813979 or email us at hello@ninegrp.com – we're happy to help!



Paper Products

Toilet Roll – Mini Jumbo – 76mm Core

Pack of 12

2-ply mini jumbo toilet tissue offers a practical, cost-effective solution for high-traffic washrooms, delivering reliable performance and reduced refill frequency.

Dispenser – See page 109

- Features:
- Soft and absorbent 2-ply paper for user comfort
 - Professional appearance for all washroom types



Toilet Roll – Mini Jumbo – 76mm Core – Pack of 12

SKU:	Qty:
NG HY911050-76	Pack of 12
NHSSC	

Toilet Roll – Luxury 3 Ply

Pack of 40

Luxuriously quilted 3 ply toilet tissue at an affordable price. Each roll is made in the UK using soft, gently tissue that flushes with ease

- Features:
- Soft and gentle
 - Responsibly sourced



Toilet Roll – Luxury 3 Ply – 40 Pack

SKU:	Qty:
NG HY911055-3	Pack of 40
NHSSC	

Toilet Roll – Eco 2 Ply

Pack 40

Eco 2 Ply Recycling Toilet Roll offers a sustainable, high-quality hygiene solution for schools, offices, and public spaces. Delivers a gentle, soft finish while maintaining strength and performance.

- Features:
- Eco-friendly
 - Soft and strong 2 Ply construction



Toilet Roll – Eco 2 Ply – Pack of 40

SKU:	Qty:
NG 11040252	Pack of 40
NHSSC	

Hand Towel 2 Ply White - Z-Fold

[3000 Sheets]

2-ply hand towels come in a Z-Fold design and are exceptionally soft, sturdy, and absorbent.

Dispenser - See page 109



Hand Towel 2 Ply
White - Z-Fold

SKU:	Qty:
NG HY911068-W	3000
NHSSC	Sheets

⋮
⋮
⋮
⋮
⋮
⋮
⋮
⋮
⋮
⋮

Features:

- Quality paper towels
- Cost Effective

Hand Towel 2 Ply White C-Fold

[2430 Sheets]

Folded towels provide superior hygiene, as users usually touch only the towel they take, lowering the risk of cross-contamination compared to Z or V fold options.

Dispenser - See page 109



Hand Towel 2 Ply
White C-Fold

SKU:	Qty:
NG HY911065-W	2430
NHSSC	Sheets

⋮
⋮
⋮
⋮
⋮
⋮
⋮
⋮
⋮
⋮

Features:

- Hygienic single use disposable towel
- Cost effective

V-Fold Flushable White Hand Towel

[2400 Sheets]

Single fold hand towels, designed to reduce consumption, waste, and refill frequency. Flushable and safe for use in restrooms where towels may be disposed of in the toilet.

Dispenser - See page 109



V-Fold Flushable
White Hand Towel

SKU:	Qty:
NG 11040240	2400
NHSSC	Sheets

⋮
⋮
⋮
⋮
⋮
⋮
⋮
⋮
⋮
⋮

Features:

- Flushable
- V Fold hand towel

Hand Paper Towel – Centrefeed – Standard [150m]

Disposable paper towels that are made in the UK from Centrefeed, making them strong, durable and absorbent. Large sheet size to achieve thorough cleaning and wiping tasks while reducing the number of sheets used. High quality and reliable, exactly what you need with disposable towels.

- Features:**
- Fast and hygienic way of cleaning up spills



Hand Paper Towel – Centrefeed Blue Roll – 150m – Standard – Case of 6

SKU:	Qty:
NG 11040281-02 NHSSC	Pack of 6



Hand Paper Towel – Centrefeed White Roll – 150m Standard – Case of 6

SKU:	Qty:
NG 11040281-05 NHSSC	Pack of 6

Centrefeed Paper Dispenser – Large

Space-saving and easy to restock, the centrefeed dispenser has been designed for areas that require fast access to paper towels. The hard-wearing centrefeed dispenser will stand up to years of constant use in busy environments.

- Features:**
- Manufactured in the UK
 - ABS plastic cover, window ; backplate
 - Large viewing window
 - Single sheet adaptor available
 - Key lockable cover, fixing kit provided



Centrefeed Paper Dispenser – Large

SKU:	Qty:
NG 12220155-05 NHSSC	1

Paper Hand Towel Dispenser Premium White

The modular hand towel dispenser is an ultra-strong dispenser that fits a wide range of hand towels interleaved, C-fold, Z-fold paper towels.



Paper Hand Towel
Dispenser - Premium
White - Large

SKU:	Qty:
NG 12100010-05 NHSSC	1



Paper Hand Towel
Dispenser - Premium
White - Small

SKU:	Qty:
NG 12100010-03 NHSSC	1

Features:

- Manufactured in the UK
- ABS plastic cover, window; backplate
- Single towel dispensing minimises waste
- Large viewing window
- Adaptor plate available for extra-narrow towels
- Key lockable cover, fixing kit provided

Toilet Roll Dispenser - Jumbo

Modular jumbo toilet roll dispenser. The integrated reversible spigot enables the use of different roll-core diameters which increase the amount of application possibilities.



Toilet Roll Dispenser -
Jumbo

SKU:	Qty:
NG 12220152-04 NHSSC	1

Features:

- Manufactured in the UK
- Ideal for high traffic area's, requiring less replenishment
- Key lockable cover, front window to check stock levels

Hygiene Couch Roll - 20" [50cm] x 40m

An absorbent, versatile and strong 2ply white hygiene roll. A cost-effective disposable hygiene cover for chairs, tables or similar surfaces and is also a very efficient wiper roll.

- Features:**
- Manufactured in the UK, according to CHSA Soft Tissue Standard.
 - Made using quality 100% recycled fibres and is FSC Certified. Each roll measures 50cm in width and 40m in length.
 - 2ply perforated sheets are highly absorbent and can be used for light-duty wiping tasks.



Hygiene Couch Roll 20" [50cm] x 40m White (Case of 9)

SKU:	Qty:
NG 11040272-01 NHSSC	Case of 9

Hygiene Couch Roll 20" [50cm] x 40m White (Case of 12)

SKU:	Qty:
NG 11040273-01 NHSSC	Case of 12



Hygiene Couch Roll 20" [50cm] x 40m Blue (Case of 12)

SKU:	Qty:
NG 11040272-02 NHSSC	Case of 12

Hygiene Couch Roll - 10" [25cm] x 40m



Hygiene Couch Roll 10" [25cm] x 40m
White (Case of 18)

SKU:	Qty:
NG 11040271-01 NHSSC	Case of 18



Hygiene Couch Roll 10" [25cm] x 40m
Blue (Case of 24)

SKU:	Qty:
NG 11040271-02 NHSSC	Case of 24



Clean faster. Disinfect smarter.

Uni9 Multi Purpose Range

-  Multi-surface cleaning & disinfecting for high-traffic areas
-  The Go-To solution for Catering

See pages 96 to 97 & 153

Medi9



medi9

Medi9 is a revolutionary range of infection control products that provide alcohol and chlorine free hand and surface germ protection solutions. Our entire range is tested independently, and proven effective against bacteria, spores, viruses, and fungi upon contact, including Clostridium Difficile, MRSA, Norovirus, Swine Flu and Coronavirus.

Medi9 is used in multiple healthcare facilities, including NHS trusts, ambulance services, schools, and commercial sectors. It is a unique, highly effective solution to sanitisation without the introduction of harsh chemicals such as alcohol or chlorine. Nine Group produce a large range of products in the Medi9 portfolio to ensure complete coverage of any infection control requirement.

Medi9 provides piece of mind. It comes ready to use (RTU), so you can simply grab and go and this minimises human error. Clinically proven results. Every time. Everywhere.

We are constantly researching and developing new environmentally innovative products for the Medi9 range. Medi9 products are manufactured in the UK, allowing us to reduce our carbon foot print and maintaining high quality products.

How effective is it?

Medi9 is a 'Beyond the Quat' fourth generation biocide technology which works by physically damaging the bacteria or cell. It consists of a polymer and biocidal agent that helps it penetrate and deactivate viral cells.

Medi9 Personal Health Protection Kit

Medi9 Personal Health Protection Kits have been designed as infection control kits to protect anyone who is working in an area where there is a high risk of infection or contamination - for example, those handling patients that have contracted Ebola, swine flu, Norovirus and the like.

They can also be used at crime scenes and as protection for front line personnel attending a disaster scenario. The kits are packaged compactly in a securely sealed bag and designed so that the contents, once used, can be contained in a clinical waste bag, cable-tied and sent away for disposal.



Features:

- *Coverall provides protection against airborne particles and fibres. Zip front with adhesive backed cover flap. Certified to EN13982-1, EN13034, EN14126, EN1073-2 & EN1149-5
- **Goggles are lightweight, extremely durable and, with an indirect vent
- Provides protection from liquid splashes as well as large dust particles. Certified to EN166:2001
- All items can be disposed of in clinical waste sack provided
- Bespoke kits can be assembled to your requirements

Kit Content:

- 1 x Coverall*
- 4 x Universal Wipes (2 x per sachet of 2)
- 2 x Pair of Large Gloves
- 1 x Disposable Apron
- 1 x Clinical Waste Sack
- 1 x Cable Tie
- 1 x Pair of Overshoes
- 1 x Pair of Oversleeves
- 1 x FFP3 Disposable Face Mask
- 1 x Pair of Goggles**
- 1 x 30ml Medi9 Surface Spray
- 1 x Instruction Sheet

SKU:

Qty:

NG	11050320-04	Medium Kit
	11050320-05	Large Kit
	11050320-06	X-Large Kit
	11050320-07	XX-Large Kit



Have a question?

Call on 01726 813979
or email us at
hello@ninegrp.com –
we're happy to help!

Medi9 Sanitised Personal Hand Foam

Medi9 alcohol free Hand Sanitising Foam provides rapid, long lasting disinfection and biological cleanliness to all hard working hands. The high performance formulation coats the skin with a monomolecular layer that continues providing protection long after the initial application. Regular use ensures sustained broad spectrum pathogen protection.

Medi9 Hand Sanitising Foam is suitable for use in high traffic locations where soap and water are not available or in areas where a higher level of hand sanitisation is required. Wall brackets and bed brackets which allow the product to be hung in readily accessible areas are also available.

Features:

- RTU (Ready To Use)
- Apply, rub and go - no need to rinse off
- Provides residual protection
- Use for prevention and for cure
- Fragrance free
- Safe for use in food preparation areas
- Alcohol, chlorine and triclosan free
- Non-hazardous - safe for use in the vicinity of vulnerable people and children
- Safe to use in challenging environments and on sensitive equipment
- REACH and COSHH exempt



Medi9 Sanitised Personal Pocket Hand Foam 50ml

SKU:	Size:
NG 18104010 NHSSC	50ml



Medi9 Sanitised Personal Hand Pump Foam 200ml

SKU:	Size:
NG 18104012 NHSSC	200ml



Medi9 Sanitised Personal Hand Pump Foam 600ml

SKU:	Size:
NG 18104014 NHSSC	600ml

Medi9 Sanitised Personal 750ml Refill [Manual & Automatic Hand Dispenser]



Medi9 Sanitised Personal 750ml Refill Dispenser Pouch

SKU:	Size:
NG 18104018 NHSSC	750ml Pouch

Medi9 Sanitised Personal Manual & Automatic Hand Dispenser

Medi9 Hand Dispensers help to keep hands disinfected and biologically clean when on the move.

Medi9 Dispensers are an excellent solution for public areas such as restaurants, bars, ballrooms and corridors. The Medi9 Hand Sanitising Foam provides total germ protection to hands against bacteria, spores, viruses and fungi including Clostridium Difficile, MRSA, Ebola, Norovirus and Coronavirus.

- Features:**
- Manufactured from rugged and durable high quality plastics which can be easily recycled
 - Simple and easy to install
 - Easy to clean and wipe down
 - Easy to reload
 - Securely locked with key access



Medi9 Sanitised Personal Manual Dispenser

SKU:	Product:
NG 18104030 NHSSC	Manual



Medi9 Sanitised Personal Automatic Dispenser

SKU:	Product:
NG 18104040 NHSSC	Automatic



Medi9 Sanitised Personal Dispenser Stand



SKU:		Product:
NG	18104042 ME904050	Dispenser Stand Automatic Dispenser Foam Hand Refill - 750ml
NHSSC		

Medi9 Sanitised Personal Hand & Body Wipes

Medi9 Hand Sanitising Wipes provide up to 200 applications of long lasting germ protection to hands. The high performance sanitising wipes have been independently proven to be effective against bacteria, spores, viruses and fungi.

Each wipe contains a gentle, alcohol free sanitising solution which leaves hands soft, refreshed and sanitised in seconds. The ready to use no water formulation provides easy instant germ protection to busy hands any time, any place, anywhere.

Features:

- Safe to use on hand and body
- Large wipes size
- Provides residual protection
- Use for prevention and for cure
- Fragrance free
- Safe for use in food preparation areas
- REACH and COSHH exempt
- Non-hazardous - safe for use in the vicinity of vulnerable people and children
- Alcohol, chlorine and triclosan free
- Safe to use in challenging environments and on sensitive equipment
- Tough and longer lasting



Medi9 Sanitised Personal Hand & Body Wipes [225]

SKU:		Qty:
NG	18104025	225
NHSSC		



Medi9 Sanitised Personal Hand & Body Wipes [200]

SKU:		Qty:
NG	18104020	200
NHSSC		

Medi9 Sanitised Spaces Vehicle Sanitisation System [12v & 24v]

All Nine Group Sanitisation Systems have the smallest possible nozzle opening to produce the optimum air pressure, which counters gravity and ensures the longest possible time to be airborne. When landed on a surface, Medi9 provides up to 18 hours of residual protection, and, as it is positively charged, is attracted to all horizontal and vertical surfaces. The Medi9 Vehicle Sanitisation System generates a force of air which transports finely atomised Medi9 Vehicle Sanitising Solution across large areas on to surfaces and equipment.

The Medi9 solution settles on surfaces killing 99.9% of bacteria, spores, viruses and fungi on contact including Clostridium difficile, MRSA, Ebola, TB and Norovirus. Medi9, whilst highly effective is non-corrosive, which means it is easier and a lot more time efficient to use.

The Medi9 Vehicle Sanitisation System comes in a robust stainless-steel case and is specifically designed for vehicles which do not require compressed air. It enables vehicle decontamination whilst the vehicle is stationary or in transit. It is used in a wide range of vans and vehicles, including but not limited to those transporting critical loads in line with CFPP 01-04, HTM0104 and BS EN 14065 requirements.

- Features:**
- Disinfection: 5 minutes approximately
 - 12 months warranty on parts, providing the system has been serviced within the first 6 months to ensure correct usage of the system
 - Medi9 required for the Vehicle Sanitiser - 5 litres
 - Service recommended every 12 months. For heavily used systems a period of 6 months is recommended

Medi9 Sanitised Spaces Vehicle Sanitisation System [12v & 24v]

SKU:	Product:
NG ME908002-12v ME908002-24v 18141020	System xl System xl 5L
NHSSC	



Medi9 Sanitised Spaces Air Sanitisation Solution

The Medi9 Air Sanitisation Solution is designed & manufactured for use in the Medi9 sanitising units. This high-performance solution is independently proven effective against 99.9% of bacteria, spores, viruses, and fungi including Coronavirus, Clostridium Difficile, MRSA and Norovirus.

Used regularly and effectively, you can relax, safe in the knowledge that the areas you have operated in have been completely sanitised, providing easy instant germ protection to any environment where the transfer of germs is a concern and gives a safe working environment.

Features:

- RTU - ready to use - very important to avoid human error and water contamination
- No need to rinse or wipe down after application
- Provides residual protection - use as prevention as well as cure
- Fragrance-free, Non-hazardous
- Alcohol, chlorine and triclosan-free
- Safe to use in challenging environments and on sensitive equipment
- REACH and COSHH exempt



Medi9 Sanitised Spaces
Air Sanitisation Solution 20L

SKU:	Size:
NG ME901014 NHSSC	20L



Medi9 Sanitised Spaces
Air Sanitisation Solution 5L

SKU:	Size:
NG 18141020 NHSSC	5L

Medi9 Interior Clean Room HPV Tape

Medi9 HPV Tape is uniquely designed to meet the needs of professional users. The tape has a specialist adhesive which is designed to remove cleanly from internal hard and soft surfaces. Our tape is designed for critical environment adhesion level but good cohesive strength, leaves no residue and is resistant to acids and other chemicals.

Our HPV Tape is ROHS certified and meets COSHH regulations. The tape is manufactured with an embossed pattern which has the benefit of NO marks being left by this technologically advanced product, and tears straight.

The tape has been designed from a specialist flexible Polyvinyl chloride, also known as poly vinyl or vinyl, commonly abbreviated PVC and does not have any ability to breathe, this allows the product to be used in critical applications against water or vapour ingress.

Features:

- Leaves no residue marks
- Easy to Tear, no scissors required
- Designed & manufactured for the NHS for HPV operations
- Advanced innovative channel seal that lock-in specialist adhesive



Medi9 HPV Tape

SKU:	Qty
NG 11040128	Each
NHSSC	



Medi9 Sanitised Surfaces Bulk Solution

Medi9 Surface Sanitising Solution is designed to bring broad spectrum pathogen protection and biological cleanliness to large areas in an instant.

This high performance sanitising solution is independently proven to be effective against bacteria, spores, viruses and fungi including Coronavirus, Clostridium difficile, MRSA and Norovirus.

Features:

- RTU - Ready to use
- Provides residual protection - use as prevention as well as cure
- Excellent finish on chrome, stainless steel and aluminium
- Fragrance free - Safe for use in food preparation areas
- Non-hazardous - safe for use in the vicinity of vulnerable people
- Alcohol, chlorine and triclosan free.



Medi9 Sanitised Surfaces Bulk Solution 20L

SKU:		Size:
NG	ME901020	20L
NHSSC		



Medi9 Sanitised Surfaces Bulk Solution 5L

SKU:		Size:
NG	18041015	5L
NHSSC		



Medi9 RTU Surface Sanitiser Labelled Heavy Duty Trigger Spray Bottle - Blue Trigger [Empty]

SKU:		Size:
NG	12040644-02	750ml
NHSSC	MK085626	

Medi9 Surface & Equipment Universal Wipes

Medi9 Universal Wipes provides long lasting germ protection to surfaces. The high performance sanitising wipes have been independently proven to be effective against bacteria, spores, viruses and fungi including Coronavirus, Clostridium difficile, MRSA and Norovirus.

Each wipe contains a gentle, alcohol free sanitising solution which leaves surfaces biologically cleansed and sanitised in seconds. The ready to use no water formulation provides easy, instant germ protection to surfaces any time, any place, anywhere.

- Features:**
- Safe to use on all surfaces
 - Large wipes size, Fragrance free
 - Provides residual protection
 - Use for prevention and for cure
 - Safe for use in food preparation areas
 - Alcohol, chlorine and triclosan free
 - Non-hazardous - safe for use in the vicinity of vulnerable people and children
 - Safe to use in challenging environments and on sensitive equipment
 - REACH and COSHH exempt
 - Tough and longer lasting



Medi9 Surface & Equipment Universal Large Wipes [225]

SKU:	Qty:
NG 18160215	225
18160216	
NHSSC	225 [Refill]



Medi9 Surface & Equipment Universal Large Wipes [200]

SKU:	Qty:
NG 18160208	200
18160209	
NHSSC	200 [Refill]



Medi9 Surface & Equipment Medical Device Wipes [200]

SKU:	Qty:
NG ME903004	200
NHSSC	

Medi9 Surface & Equipment Spray and Foam

Medi9 Surface Sanitising Spray/Foam is designed for every day use in environments where the transfer of germs is a concern.

This high performance sanitising spray/foam is independently proven to be effective against bacteria, spores, viruses and fungi including Coronavirus, Clostridium difficile, MRSA and Norovirus. Each application brings broad spectrum pathogen protection and biological cleanliness to large areas in an instant. From floors, walls and surfaces to equipment and apparatus, the alcohol free, ready to use, no water formulation provides easy instant germ protection to any environment in seconds.

Features:

- RTU - Ready to use
- Handy size trigger spray bottle
- Spray on, wipe and leave - no need to rinse off
- Provides residual protection - use as prevention as well as cure
- Excellent finish on chrome, stainless steel and aluminium
- REACH and COSHH exempt
- Fragrance free - Safe for use in food preparation areas
- Non-hazardous - safe for use in the vicinity of vulnerable people
- Alcohol, chlorine and triclosan free
- Safe to use in challenging environments and on sensitive equipment



Medi9 Surface & Equipment Spray - 650ml

SKU:	Size:
NG 18041006 NHSSC	650ml



Medi9 Surface & Equipment Foam - 650ml

SKU:	Size:
NG ME901003 NHSSC	650ml



Medi9 Surface & Equipment Mini Spray - 30ml

SKU:	Size:
NG 18041004 NHSSC	30ml



Washroom

P-Wave® NHS [Cancer Symptom Message] Slant6 Deodorant Biodegradable Urinal Screen

Each P-Wave® Slant6 urinal screen is compatible with waterless urinals and packs functionality and sustainability in a smaller size, fitting more urinals than its predecessors, and of course, is easy to install. Up to five times the fragrance power of its competition. It infuses your space with an invigorating freshness that lasts for a minimum of 30 days, making it one of the most potent and enduring urinal screens available.



P-Wave® NHS (Cancer Symptom Message) Slant6 Deodorant Biodegradable Urinal Screen - Cotton Blossom

SKU:	Qty:
NG 11041420-15	Pack of 10
NHSSC MKO85624	

- Features:**
- High fragrance load for a long-lasting fresh aroma
 - EcoPure® additive enhances faster biodegradation
 - 'Splash-eliminating' angled bristle design
 - Double-sided, 'Anyway Up' installation
 - Contains beneficial bacteria for deodorising
 - Waterless urinal compatibility
 - Lower VOC's
 - Recyclable where facilities exist

P-Wave® Bowl Clip Air Freshener - Cotton Blossom

The P-Wave® Bowl Clip is engineered to effortlessly clip over the exterior of your toilet rim (underneath the seat). However, don't let the name limit its potential. This power-packed clip can be placed virtually anywhere you desire freshness - no batteries, electricity, or harmful aerosols required. This recyclable clip offers a strong fragrance that lasts for a whole month! It's perfect for toilet bowls, office privacy screens/dividers, cars, or even hanging over a door.



P-Wave® NHS Bowl Clip Air Freshener - Cotton Blossom

SKU:	Qty:
NG 11041422-15	Pack of 12
NHSSC MKJ85792	

- Features:**
- Bursting with long-lasting fragrance
 - Strategically designed to fit the outside of the toilet rim, underneath the seat
 - Low in VOCs (Europe compliant)
 - Recyclable where facilities exist
 - Easy to install and replace
 - Does not dissolve in or pollute water
 - Incredible versatility - can be hung from pipework behind the toilet too!

P-Wave® Eco Air Freshener Air – 100% Recyclable – Cotton Blossom

A sustainable, spill-free fragrance solution that delivers powerful, long-lasting freshness with minimal impact on the planet. Meet Eco Air – the compact, eco-friendly fragrance solution with serious impact! No noisy aerosols, no spills – just pure, dry fragrance that fills your space effortlessly. Eco Air's recyclable design works solo or fits neatly inside our Eco Air cabinets, lasting 30 days with a 16m² range.



P-Wave® Eco Air Freshener
Air – 100% Recyclable –
Cotton Blossom

SKU:

Qty:

NG **11041430-15**

Pack

NHSSC **MKJ85796**

of 6

Features:

- Kinder to the environment than aerosol air fresheners.
- Open-air design creates maximum surface area exposure and space for air flow which provides effective and efficient fragrance release.
- Position in an area with good air flow for best results
- Use with or without wall holder (purchased separately)
- No batteries, aerosols, propellants or solvents, just fragrance.

P-Wave® Eco Air Freshener Dispenser Cabinet – White



P-Wave® Eco Air Freshener
Dispenser Cabinet – White

SKU:

Qty:

NG **11041428**

1

NHSSC **MKJ85789**

P-Wave® Curve Air Freshener – 100% Recyclable – Cotton Blossom

The P-Wave® Curve – redefining the concept of freshness and bringing an unprecedented experience to your surroundings.

Envision a scent that’s up to 50 times more potent than your conventional toilet rim stick. Available in five fragrances, lasts 30 days with coverage up to 12m2.

Features:

- The powerful ‘almost anywhere’ air freshener and use supplied curve holder to fix to any hard surface.
- Available in five fab fragrances of Mango, Spiced Apple, Citrus, Cotton Blossom & Fabulous (Lavender) with coverage up to 12m2.
- Relies on air movement and so for best results install in an area with good air flow.
- No batteries, aerosols, propellants or solvents, just fragrance.
- Dry fragrance technology with no liquids, spills or sticky residues
- Made from recyclable EVA (where facilities exist) and contains up to 15% recycled content.



P-Wave® Curve Air Freshener – 100% Recyclable – Cotton Blossom – Pack of 10

SKU:	Qty:
NG 11041425-15 NHSSC MKJ85786	Pack of 10

P-Wave® Curve Holder – White



P-Wave® Curve Holder – Pack of 30

SKU:	Qty:
NG 11041426 NHSSC MKJ85780	Pack of 30

P-Wave® Easy Fresh Air Freshener Fragrance Cover – Cotton Blossom

The Easy Fresh system comes with low battery and cover change warning lights, and an audible beep, keeping you informed and ensuring timely replacements. Packed with fragrance yet low in Volatile Organic Compounds (VOCs), it is compliant with European standards, further affirming our commitment to a healthier environment. The Easy Fresh system ensures a constant release of fragrance from the recyclable cover, filling the room for a full 30 days. Powered by a light-activated fan, it's engineered to work harder as the cover nears its end-of-life, ensuring a consistent fragrance delivery.

Features:

- Loaded with long-lasting fragrance
- Recyclable where facilities exist
- Ensures constant fragrance, with no peaks and valleys compared to an aerosol
- Low in VOCs (Europe compliant)
- Fan helps to distribute the fragrance around the room, covering up to 25 sq metres
- Intelligent fan powers down when the lights go off to conserve the battery
- Versatile fitment – can be placed on a wall or ceiling and at any height



P-Wave® Easy Fresh Air Freshener Fragrance Cover – Cotton Blossom – Pack of 12

SKU:		Qty:
NG	11041435-15	Pack of 12
NHSSC	MKJ85798	

P-Wave® Easy Fresh Air Freshener Dispenser



P-Wave® Easy Fresh Air Freshener Dispenser

SKU:		Qty:
NG	11041434	1
NHSSC	MKJ85795	

P-Wave® MyFresh Air Freshener Fragrance Refill – 100% Recyclable – Alpine Forest

MyFresh offers discreet fragrance targeting, freshening your surroundings when and where it's needed the most. Ideal for toilet cubicles, vanity mirrors, lifts, gyms, spas, or even a desk in an office, it provides a better user experience than aerosol alternatives. Its handy LCD screen alerts you when it's time to replace the refill and battery. Plus, you can adjust the fan's frequency settings between "Hi" and "Lo" to suit your preference.

The recyclable, dry fragrance refill promises a cleaner experience with no wet residue. Charcoal filters purify the incoming air for a fresher experience, and the unit operates on a single AA battery, which is included with each refill.



P-Wave® MyFresh Air
Freshener Fragrance Refill
– 100% Recyclable – Alpine
Forest – Pack of 6

SKU:		Qty:
NG	11041440-21	Pack of 12
NHSSC	MKJ85782	

- Features:**
- All new sleek 2.0 MyFresh unit with upgraded fan
 - Recyclable Dry Fragrance refill = Cleaner with no wet residue
 - Motion-activated freshness
 - Charcoal filters for purified air
 - High-velocity FreshFan technology for optimal fragrance distribution
 - Lockable unit for safety and control
 - LCD screen for timely refill and battery replacement
 - Adjustable frequency settings
 - Compact size (76mm x 76mm) for personal spaces
 - Single AA battery operation (included with each refill)

P-Wave® MyFresh Air Freshener Dispenser



P-Wave® Easy Fresh Air
Freshener Dispenser

SKU:		Qty:
NG	11041438	1
NHSSC	MKJ85797	

Uni9 Glass Cleaner

Instant Clear

Uni9's Universal Instant Clear Glass Cleaner will leave your glass, chrome and mirrors instantly sparkling due to its ability to dry quickly. It is also safe to use on all ceramic and stainless steel.



Uni9 Glass Cleaner
Instant Clear - 750ml

SKU:	Size:
NG 19041040	750ml
NHSSC MKJ85473	

Features:

- Powerful cleaning
- Water rinsable
- Chlorine free
- Biodegradable

Uni9 Toilet Cleaner

Cleaning & Descaling

Uni9's Universal Toilet Cleaner is a remarkable product, it cleans and descales, prolonging contact time of product to surfaces due to its specially thickened consistency. Uni9's Universal Toilet Cleaner completes a number of tasks with one process, it will clean, descale, deodorise and kill bacteria in one operation. It can be used on all ceramic and plastic sanitary products. Will not effect stainless steel. With regular use it will leave deposit free hygienic fittings.



Uni9 Antibacterial Toilet
Cleaner & Descaler - 1L

SKU:	Size:
NG 19041022	1L
NHSSC MKJ85937	

Features:

- Descales
- Disinfects
- Powerful cleaning
- Water rinsable
- Chlorine free
- Bactericidal
- Biodegradable

Daily Toilet Cleaner 1L

Toilet Cleaner effectively removes limescale, grime and soiling, whilst killing 99.9% of bacteria and viruses. Regular use prevents the build-up of limescale and soiling where bacterial growth and bad odours originate.



Daily Toilet Cleaner – 1L

SKU:	Size:
NG 11040662-01 NHSSC MKJ85481	1L

Features:

- Kills 99.9% of bacteria and viruses**
- Suitable for regular use on porcelain and stainless steel

**Kills 99.9% of bacteria and viruses including MRSA according to BS EN 1276, BS EN 13697, BS EN 14476.

Daily Toilet Cleaning Gel 'Ocean' 750ml

Effective against a wide range of bacteria and viruses, the bleach adheres to surfaces providing longer, more efficient cleaning and leaves porcelain sparkling and hygienic.



Daily Toilet Cleaning Gel – Ocean – 750ml

SKU:	Size:
NG 11040662-07 NHSSC MKJ85468	750ml

Features:

- Effective against a range of bacteria & viruses

Washroom Cleaner [Concentrate] 5L

Super Concentrated Washroom Cleaner is specially formulated for rapid and easy cleaning of all surfaces in the washroom.

Effortlessly cuts through grease and grime. Leaves surfaces clinically clean whilst helping to prevent the build up of limescale.



Washroom Cleaner Concentrate – 5L

SKU:	Size:
NG 11040682-05 NHSSC MKJ85477	5L

Features:

- Effortlessly cuts through grease and grime
- Prevents the buildup of limescale
- Can be diluted into a trigger bottle

Uni9 Fast & Effective Floor & Hard Surface Cleaner

Uni9's Floor & Hard Surface Cleaner has a wide range of cleaning qualities, meaning that it can be used on a wide range of hard surfaces to give an excellent finish from either buffing or mopping.

Uni9's Floor & Hard Surface Cleaner completes a number of tasks with one process, it will clean, deodorise and kill bacteria in one application. It has been produced fragrance-free or with a pleasant lemon aroma to complement the finished area. With a dilution rate of 1:15, Uni9's Floor & Hard Surface Cleaner is not only an efficient hard surface cleaner but also a cost effective solution for all hard surface cleaning applications. Suitable for auto dosing systems.

Features:

- Antibacterial properties
- Cleans, disinfects and deodorises in one application
- Water rinsable
- Chlorine free



Uni9 Hard Surface Floor Cleaner
Concentrate - Lemon 20L

SKU:	Size:
NG 19041017 NHSSC	20L



Uni9 Hard Surface Floor Cleaner
Concentrate - Lemon 5L

SKU:	Size:
NG 19041015 NHSSC MKM85035	5L



Uni9 Hard Surface Floor Cleaner
Concentrate - Lemon 1L in Dosing Bottle

SKU:	Size:
NG 19041013 NHSSC MKM85037	1L (Auto Dose Bottle)



Uni9 Floor/Hard Surface Cleaner
Labelled Heavy Duty Trigger Spray
Bottle - Yellow Trigger [Empty]

SKU:	Size:
NG 12040644-04 NHSSC MKJ85790	750ml

Uni9 Universal Bathroom / Washroom Cleaner Foam

Uni9 Universal Bathroom / Washroom Cleaner is a remarkable cleaning product, acting as a powerful bactericidal cleaner, degreaser, disinfectant, and deodoriser all in one single action.

Uni9's Universal Bathroom / Washroom Cleaner industrial strength cleaning power digs out tough grease and grime and is an exceptional 'one product does it all' for all types of maintenance, deep cleaning and disinfection.

Features:

- Fragrance free
- Safe to use in all areas
- Degreases & cleans in one application



Uni9 Universal Bathroom / Washroom Cleaner Foam 750ml

SKU:

Size:

NG	UN908030
NHSSC	

750ml



Washable Grout/Deck Brush [23cm]

Multi-swivel brush head with stiff, angled bristles, ideal for thorough cleaning of tiled floor areas.

Handles - See pages 34 & 35

- Features:**
- Colour coded
 - Machine washable to ensure better hygiene.
 - T1 screw thread fitting



Washable Grout/Deck Brush Red [23cm]

SKU:	Qty:
NG HY923014R NHSSC	23cm



Washable Grout/Deck Brush Blue [23cm]

SKU:	Qty:
NG HY923014B NHSSC	23cm



Washable Grout/Deck Brush Green [23cm]

SKU:	Qty:
NG HY923014G NHSSC	23cm



Washable Grout/Deck Brush Yellow [23cm]

SKU:	Qty:
NG HY923014Y NHSSC	23cm

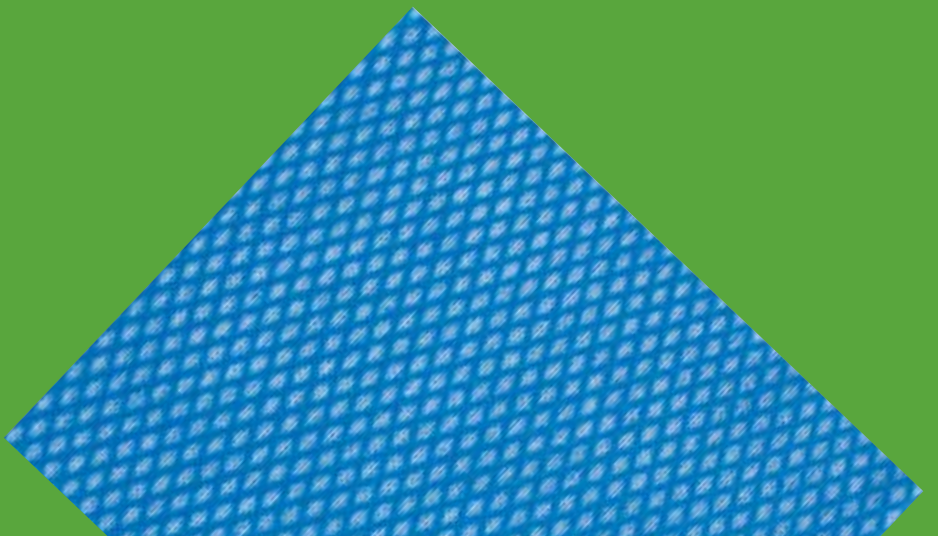

Cloths

Disposable Cleaning Cloths [Standard]

All-purpose cleaning cloths.

For single use where hygiene is a key concern. Made from polyester with an added hydrophollic agent.

- **Features:**
- – Disposable
- – Use wet or dry
- – Food contract compliant
- – Rinse after use



Cloth Non Microfibre Red
[42 x 35cm] – Pack of 50

SKU:	Qty:
NG 11040490-01 NHSSC MKC85571	Pack of 50



Cloth Non Microfibre Blue
[42 x 35cm] – Pack of 50

SKU:	Qty:
NG 11040490-02 NHSSC MKC85659	Pack of 50



Cloth Non Microfibre Green
[42 x 35cm] – Pack of 50

SKU:	Qty:
NG 11040490-03 NHSSC MKC85574	Pack of 50



Cloth Non Microfibre Yellow
[42 x 35cm] – Pack of 50

SKU:	Qty:
NG 11040490-04 NHSSC MKC85576	Pack of 50

Disposable Non Microfibre Cleaning Cloth [Pack of 25]

A versatile, heavy-duty wipe with excellent absorbency, containing an antibacterial agent that helps prevent bacterial growth and odours.

- Features:**
- Thick, strong and durable
 - Wipes can be washed and reused
 - Food contact safe
 - Made from a viscose, polyester and antibacterial blend.



Non Microfibre Disposable Cleaning Cloth - Red - Pack of 25

SKU:	Qty:
NG 11040492-01 NHSSC MKC85578	Pack of 25



Non Microfibre Disposable Cleaning Cloth - Blue - Pack of 25

SKU:	Qty:
NG 11040492-02 NHSSC MKC85394	Pack of 25



Non Microfibre Disposable Cleaning Cloth - Green - Pack of 25

SKU:	Qty:
NG 11040492-03 NHSSC MKC85579	Pack of 25



Non Microfibre Disposable Cleaning Cloth - Yellow - Pack of 25

SKU:	Qty:
NG 11040492-04 NHSSC MKC85580	Pack of 25

Handy Roll Disposable Cloth

[Pack of 2 x 350 Sheets / 22x37cm]

A lightweight, cost-effective, semi-disposable cleaning wipe supplied on a perforated roll, designed for excellent absorbency and effective dirt pickup

- Features:**
- The Handy roll contains 350 sheets
 - Food contact safe
 - Made from polyester with a hydrophilic agent.



Handy Roll Disposable Cloth - Pack of 2 x 350 Sheets - (22x37cm) - Red

SKU:	Qty:
NG 11040488-01 NHSSC MKC85577	Pack 2x 350 Sheets



Handy Roll Disposable Cloth - Pack of 2 x 350 Sheets - (22x37cm) - Blue

SKU:	Qty:
NG 11040488-02 NHSSC MKC85392	Pack 2x 350 Sheets



Handy Roll Disposable Cloth - Pack of 2 x 350 Sheets - (22x37cm) - Green

SKU:	Qty:
NG 11040488-03 NHSSC MKC85575	Pack 2x 350 Sheets



Handy Roll Disposable Cloth - Pack of 2 x 350 Sheets - (22x37cm) - Yellow

SKU:	Qty:
NG 11040488-04 NHSSC MKC85581	Pack 2x 350 Sheets

Disposable Microfibre Cloth

[50 Sheets 38x32cm]

Disposable microfibre range removes 99.9% of germs, including coronaviruses.

Cost-effective microfibre cloth can be used for multi-surface, smear-free cleaning, including on stainless steel and glass. Its super soft feel enables it to be used on most surfaces. Low linting, lightweight and food contact safe, Mi-cloth is also highly absorbent and remains strong even when damp.

Features:

- Removes 99.9% of germs, including coronaviruses
- Low linting microfibre
- Single use prevents cross contamination
- Very absorbent
- Minimal water and chemical required
- Remains strong when damp
- Can be used with hypochlorite solutions
- Colour coded



Disposable Microfibre Cloth
Red - Pack of 50 [38x32cm]

SKU:

Qty:

NG **HY925025R**
NHSSC

Pack of 50



Disposable Microfibre Cloth
Blue - Pack of 50 [38x32cm]

SKU:

Qty:

NG **HY925025B**
NHSSC

Pack of 50



Disposable Microfibre Cloth
Green - Pack of 50 [38x32cm]

SKU:

Qty:

NG **HY925025G**
NHSSC

Pack of 50



Disposable Microfibre Cloth
Yellow - Pack of 50 [38x32cm]

SKU:

Qty:

NG **HY925025Y**
NHSSC

Pack of 50

Disposable Microfibre Roll

[250 Sheets per Roll / 31 x 21cm]

Disposable microfibre product that's ideal for use in hygiene critical areas like catering and medical to prevent cross-contamination, it is certified to EN 16615* which proves it removes 99.9% of germs, including coronaviruses from surfaces.

- Features:**
- Removes 99.9% of germs, including coronaviruses
 - Low linting microfibre
 - Single use prevents cross contamination
 - Very absorbent
 - Minimal water and chemical required
 - Remains strong when damp
 - Can be used with hypochlorite solutions



Disposable Microfibre Roll
- 250 Sheets per Roll -
Red (31 x 21cm)

SKU:	Qty:
NG 11040482-01 NHSSC MKC85573	Pack of 250



Disposable Microfibre Roll
- 250 Sheets per Roll -
Blue (31 x 21cm)

SKU:	Qty:
NG 11040482-02 NHSSC MKC85388	Pack of 250



Disposable Microfibre Roll
- 250 Sheets per Roll -
Green (31 x 21cm)

SKU:	Qty:
NG 11040482-03 NHSSC MKC85570	Pack of 250



Disposable Microfibre Roll
- 250 Sheets per Roll -
Yellow (31 x 21cm)

SKU:	Qty:
NG 11040482-04 NHSSC MKC85572	Pack of 250



Have a question? Call on 01726 813979 or email us at hello@ninegrp.com — we're happy to help!

Cleaning that takes care of the environment

- ✓ Products with PSV-certified components
- ✓ Systems designed to save water
- ✓ Production and use of clean energy
- ✓ EU Ecolabel certified textiles and trolleys
- ✓ Repairable products



Have a question and would like a virtual demo?

We can do that, schedule a time that works for you and we'll explore solutions together.

Visit www.ninegrp.com/livedemo or call **01726 813919**



SCAN TO BOOK

TTS Launderable/Washable Microfibre Cloth [Light Weight]

Resistant and absorbing multipurpose microfibre cloth. Cloth for manual cleaning of surfaces. Ideal for any type of dirt and surface.

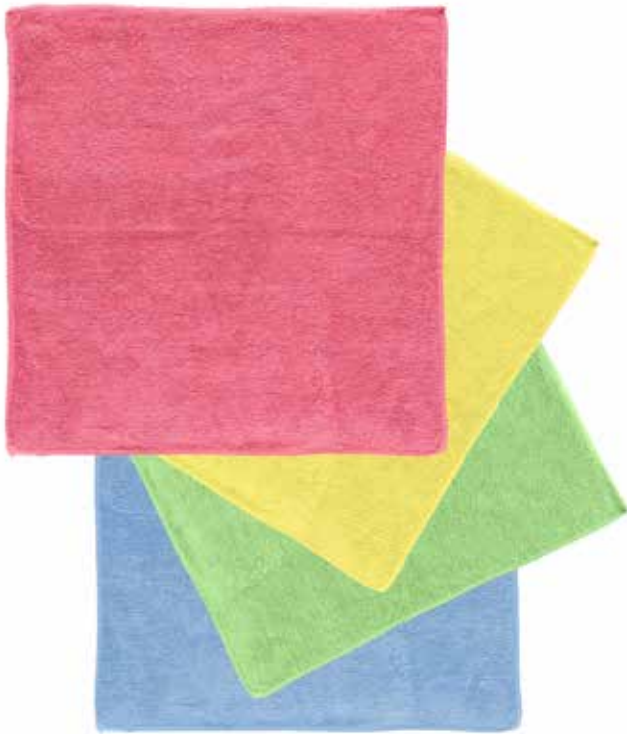

• **Features:**

- – Effective: glides on surfaces, removing and retaining dirt
- – Long-lasting: extremely durable, it guarantees a long life of the product
- – Washing temperature max 90°C, recommended 60°C

TTS Launderable/Washable Microfibre Cloth - Light Weight - Red - Pack of 20

SKU:	Qty:
NG 12040663-01 NHSSC MKC85395	Pack of 20

TTS Launderable/Washable Microfibre Cloth - Light Weight - Blue - Pack of 20

SKU:	Qty:
NG 12040663-02 NHSSC MKC85386	Pack of 20

TTS Launderable/Washable Microfibre Cloth - Light Weight - Green - Pack of 20

SKU:	Qty:
NG 12040663-03 NHSSC MKC85390	Pack of 20

TTS Launderable/Washable Microfibre Cloth - Light Weight - Yellow - Pack of 20

SKU:	Qty:
NG 12040663-04 NHSSC MKC85393	Pack of 20

TTS Launderable/Washable Microfibre Cloth [Heavy Duty]

Multipurpose microfibre cloth, handy and absorbing. Cloth for manual cleaning of surfaces. Ideal for any type of dirt and surface.

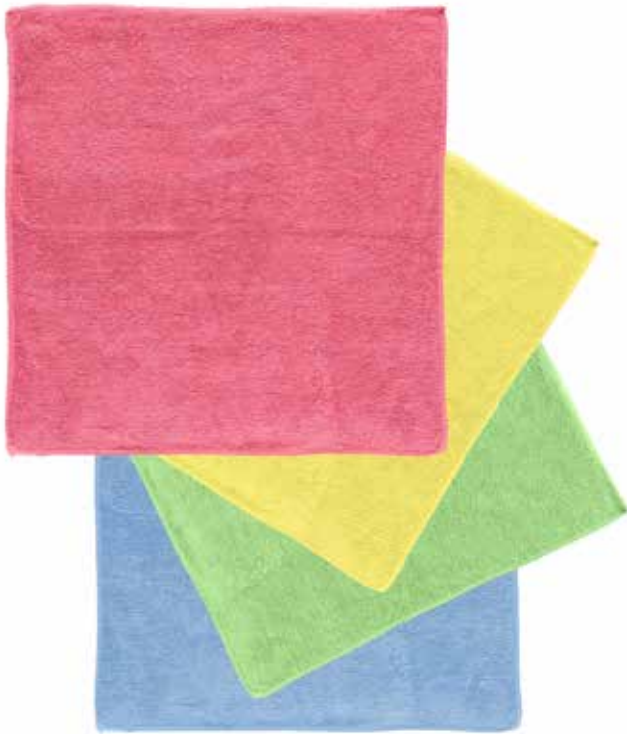

Features:

- Effective: glides on surfaces, removing and retaining dirt
- Long-lasting: extremely durable, it guarantees a long life of the product
- Washing temperature max 90°C, recommended 60°C

TTS Launderable/Washable
Microfibre Cloth - Heavy Duty -
Red - Pack of 5

SKU:

Qty:

NG	12040662-01	Pack of 5
NHSSC	MKC85389	

TTS Launderable/Washable
Microfibre Cloth - Heavy Duty -
Blue - Pack of 5

SKU:

Qty:

NG	12040662-02	Pack of 5
NHSSC	MKC85382	

TTS Launderable/Washable
Microfibre Cloth - Heavy Duty -
Green - Pack of 5

SKU:

Qty:

NG	12040662-03	Pack of 5
NHSSC	MKC85380	

TTS Launderable/Washable
Microfibre Cloth - Heavy Duty -
Yellow - Pack of 5

SKU:

Qty:

NG	12040662-04	Pack of 5
NHSSC	MKC85385	

Microfibre Cloth - Supercloth [10 Sheets 40x40cm]

is most popular knitted microfibre cloth, which is ideal for quick and effective cleaning.

The ultra-fine microfibrils capture dirt from most surfaces, are designed to create a very large surface area per fibre and are naturally statically charged so that they have a strong suction effect. In other words, they collect as much dirt as possible in just one wipe, even from the smallest surface crevices.

- Features:**
- Low linting
 - Smear-free finish
 - Ultra-fine fibres
 - Attracts dust
 - Lifts dirt and germs
 - Use dry or damp



Microfibre Cloth - Supercloth
Red - Pack of 10 [40x40cm]

SKU:	Qty:
NG HY925010R NHSSC	Pack of 10



Microfibre Cloth - Supercloth
Blue - Pack of 10 [40x40cm]

SKU:	Qty:
NG HY925010B NHSSC	Pack of 10



Microfibre Cloth - Supercloth
Green - Pack of 10 [40x40cm]

SKU:	Qty:
NG HY925010G NHSSC	Pack of 10



Microfibre Cloth - Supercloth
Yellow - Pack of 10 [40x40cm]

SKU:	Qty:
NG HY925010Y NHSSC	Pack of 10



**University Hospitals
Plymouth**
NHS Trust

Keith Morgan
Patient Services Manager Hotel Services
University Hospitals Plymouth
Site Services Department

We have been using Uni9 Multipurpose Cleaner across various areas within our hospital for several weeks now, and the feedback from our staff has been overwhelmingly positive. Team members have commented on how effective the product is at removing dirt and residue, leaving surfaces clean and fresh with minimal effort.

Staff particularly appreciate its ease of use, and versatility across multiple cleaning tasks within our ward kitchens, which has helped improve efficiency and maintain our high hygiene standards. Overall, Uni9 has proven to be a reliable, high-quality cleaning solution that consistently delivers excellent results.



**Looking for a
disposable
disinfectant
mop head...**

See page 71



Wipes

Uni9 Detergent Large Wipes

Detergent universal large wipes are disposable cleaning wipes designed for effective cleaning in healthcare settings. These wipes are pre-moistened with a detergent-based cleaning solution that allows them to remove dirt, grime, and stains from a wide range of surfaces commonly found in healthcare facilities.

- **Features:**
- – Wipes 90% recycled content
- – Made here in Great Britain for greater control
- – Sustainable System: Tub / Refills
-
-
-
-
-
-



Uni9 Detergent Large Wipes Bucket [350]

SKU:		Qty:
NG	19042125	350
NHSSC	VJT729	



Uni9 Detergent Large Wipes Bucket Refill [350]

SKU:		Qty:
NG	19042155	350
NHSSC	VJT738	



Uni9 Detergent Large Wipes Canister [200]

SKU:		Qty:
NG	19042126	5L
NHSSC	VJT725	



Uni9 Detergent Large Wipes Refill [200]

SKU:		Qty:
NG	19042156	200 [refill]
NHSSC	VJT744	

Uni9 Clean & Disinfect Multi Purpose Cleaner Wipes

Uni9's Multi Purpose Cleaner is a remarkable cleaning product, acting as a powerful bactericidal cleaner, degreaser, disinfectant and deodoriser in one single action.

Our Cleaner has industrial strength cleaning power, digging out tough grease and grime. It's an exceptional 'all-in-one product' for all types of maintenance, deep cleaning and disinfection - killing all known germs including MRSA, E.Coli, Salmonella, Pseudomonas, Staphylococcus, Enterococcus, Listeria, Legionella & many others.

Successfully removes and cleans silicone, sealant, paint, adhesive, bitumen, oil, grease, inks, expanding foam, body fluids, road film, stains, vinyls, plastics, chrome, engines, fibreglass, rubber, synthetic fabrics, plaster, enamel, tools, stainless steel and fungi. Some surfaces are inherently sensitive to alkaline cleaners; always test on an inconspicuous area first. Do not use on wool, leather or weathered surfaces.

Features:

- Kills microbes: Bactericidal, Viricidal, Yeasticidal, Fungicidal
- Fragrance free
- Safe to use in all areas
- Degreases & cleans in one application



Uni9 Multi Purpose Cleaner Wipes [225]

SKU:	Qty:
NG 19161082	225
NHSSC	



Uni9 Multi Purpose Cleaner Wipes [200]

SKU:	Qty:
NG 19161084	200
NHSSC	



Looking for high level disinfectant wipe... Look at our Medi9 range
**One Wipe.
Total Protection.**

See pages 113 to 125



Brushware / Floorcare

TTS Lampo Curved Web Brush [Pipe]

Curved web brush with Lampo hooking system for telescopic handles and poles. Web brush to dust high surfaces. Ideal to remove spider webs.

PLEASE NOTE: Jack Lampo not included

Handles - See pages 37, 38 & 174



- Features:**
- Efficient: facilitates and speeds up cleaning operations, easily reaching higher surfaces
 - Safe: remains firmly attached to the handle during use, preventing accidental release
 - Compatibility: Can be used with telescopic handle or pole with Italian thread

TTS Lampo Curved (Pipe) Web Brush

SKU:	Size:
NG 12040281 NHSSC MKO85206	35cm

TTS Lampo Curved Web Brush [Wall]

Curved web brush with Lampo hooking system for telescopic handles and poles. Web brush to dust high surfaces. Ideal to remove spider webs.

PLEASE NOTE: Jack Lampo not included

Handles - See pages 37, 38 & 174



- Features:**
- Efficient: facilitates and speeds up cleaning operations, easily reaching higher surfaces
 - Safe: remains firmly attached to the handle during use, preventing accidental release
 - Compatibility: Can be used with telescopic handle or pole with Italian thread

TTS Lampo Curved (Wall) Web Brush

SKU:	Size:
NG 12040282 NHSSC MKO85179	35cm

Wooden Broom Handle - 47" [120cm]

A sturdy 47" wooden handle with a 15/16" diameter.

- Features:**
- Tapered end



Wooden Broom Handle - 47"

SKU:	Size:
NG 12040602 NHSSC MKB85231	120cm [L] Ø 2.3cm

Wooden Broom Head – Coco 10" [25.4cm]

Wooden broom head for everyday sweeping tasks.

- **Features:**
- – Soft coco fibre bristles



Wooden Broom Head – Coco 10"

SKU:	Size:
NG 12040603 NHSSC MKB85232	25.4cm

Toilet Brush and Bowl [Contract]

A cost effective plastic toilet brush and holder in white.



Toilet Brush and Bowl – Contract

SKU:	Size:
NG 12040620 NHSSC MKB85271	40x13cm

Toilet Brush Only [Contract]

A white domed head polypropylene toilet brush.



Toilet Brush Only – Contract

SKU:	Size:
NG 12040621 NHSSC MKB85251	36x7cm

TTS Dustpan, Floor Squeegee Lobby Dusting Set & 10 bags

Kit: dustpan with rubber edge, foldable ergonomic grip with handle holder, floor squeegee and 10 bags [50x60cm]. System with dustpan and floor squeegee to collect any type of dirt, either solid or liquid. Ideal for all the places where liquids such as bars, restaurants, canteens and hospitals are handled. Compatible with all bags.

- Features:**
- Effective: rubber blade that adapts perfectly to any type of floor
 - Hygienic: floor squeegee easier to clean in comparison with the traditional dustpans with broom
 - Touch-free: the way in which the bag is fixed allows to remove it safely avoiding any contact with the hands
 - Compact: foldable grip, it reduces volume and improves transport on the trolley
 - Practical: grip equipped with handle holder



Dustpan, Floor Squeegee Lobby Dusting Set & 10 pvc bags

SKU:	Size:
NG 12040721-12 NHSSC MKB85567	32x15x97cm

Uni9 Floor & Hard Surface Cleaner [Concentrate]

Uni9's Floor & Hard Surface Cleaner has a wide range of cleaning qualities, meaning that it can be used on a wide range of hard surfaces to give an excellent finish from either buffing or mopping.

Uni9's Floor & Hard Surface Cleaner completes a number of tasks with one process, it will clean, deodorise and kill bacteria in one application. It has been produced fragrance-free or with a pleasant lemon aroma to complement the finished area.

With a dilution rate of 1:15, Uni9's Floor & Hard Surface Cleaner is not only an efficient hard surface cleaner but also a cost effective solution for all hard surface cleaning applications.

Suitable for auto dosing systems.

Features:

- Antibacterial properties
- Cleans, disinfects and deodorises in one application
- Water rinsable
- Chlorine free



Uni9 Hard Surface Floor Cleaner
Concentrate - Lemon 20L

SKU:	Size:
NG 19041017 NHSSC	20L



Uni9 Hard Surface Floor Cleaner
Concentrate - Lemon 5L

SKU:	Size:
NG 19041015 NHSSC MKM85035	5L



Uni9 Hard Surface Floor Cleaner
Concentrate - Lemon 1L in Dosing Bottle

SKU:	Size:
NG 19041013 NHSSC MKM85037	1L (Auto Dose Bottle)



Uni9 Floor/Hard Surface Cleaner
Labelled Heavy Duty Trigger Spray
Bottle - Yellow Trigger [Empty]

SKU:	Size:
NG 12040644-04 NHSSC MKJ85790	750ml



“

Paul Norris
Operational Service Lead
Basingstoke Hospital NHS Trust

NHS
Hampshire Hospitals
NHS Foundation Trust

We have been working closely with Nine Group to bring new products & cleaning materials into the trust. [We] have found them to be a very professional company when we have had issues around our stock levels. They have worked tirelessly to provide us with their products, to the point of driving up from Cornwall with products in their car in the late evening.

We currently use Nine Group's Medi9 wipes and their floor cleaning products. During the current pandemic we have also been using their fogging machines to great effect.

We have been working very closely with the Nine group to bring new products and cleaning materials into our NHS trust. They are always innovating and sharing new technology with us. It is a great working relationship.

”

Washable Brush Head – STIFF [30cm]

Polypropylene broom head with soft or stiff bristles, suitable for both indoor and outdoor sweeping

Handles – See pages 34 to 35

- **Features:**
- Washable to ensure better hygiene.
- Made from 20% recycled plastic
- Fully colour coded



Washable Brush Head – Stiff Red [30cm]

SKU:	Qty:
NG HY923012R NHSSC	30cm



Washable Brush Head – Stiff Blue [30cm]

SKU:	Qty:
NG HY923012B NHSSC	30cm



Washable Brush Head – Stiff Green [30cm]

SKU:	Qty:
NG HY923012G NHSSC	30cm



Washable Brush Head – Stiff Yellow [30cm]

SKU:	Qty:
NG HY923012Y NHSSC	30cm

Washable Brush Head – SOFT [30cm]

Polypropylene broom head with soft bristles, suitable for both indoor and outdoor sweeping

Handles – See pages 34 to 35

- **Features:**
- Washable to ensure better hygiene.
- Made from 20% recycled plastic
- Fully colour coded



Washable Brush Head – Soft Red [30cm]

SKU:	Qty:
NG HY923013R NHSSC	30cm



Washable Brush Head – Soft Blue [30cm]

SKU:	Qty:
NG HY923013B NHSSC	30cm



Washable Brush Head – Soft Green [30cm]

SKU:	Qty:
NG HY923013G NHSSC	30cm



Washable Brush Head – Soft Yellow [30cm]

SKU:	Qty:
NG HY923013Y NHSSC	30cm

Washable Grout/Deck Brush [23cm]

Multi-swivel brush head with stiff, angled bristles, ideal for thorough cleaning of tiled floor areas.

Handles - See pages 34 to 35

- Features:**
- Colour coded
 - Machine washable to ensure better hygiene.
 - Screw thread fitting



Washable Grout/Deck Brush Red [23cm]

SKU:	Qty:
NG HY923014R NHSSC	23cm



Washable Grout/Deck Brush Blue [23cm]

SKU:	Qty:
NG HY923014B NHSSC	23cm



Washable Grout/Deck Brush Green [23cm]

SKU:	Qty:
NG HY923014G NHSSC	23cm



Washable Grout/Deck Brush Yellow [23cm]

SKU:	Qty:
NG HY923014Y NHSSC	23cm

Dustpan & Brush Set [30cm]

A professional quality dustpan and brush set with soft bristles

- Features:**
- Made from tough & hardwearing plastic
 - The dustpan has a rubber lip at the front for better dirt collection



Dustpan & Brush Set - Red [30cm]

SKU:	Qty:
NG HY923030R NHSSC	23x31x10cm



Dustpan & Brush Set - Blue [30cm]

SKU:	Qty:
NG HY923030B NHSSC	23x31x10cm



Dustpan & Brush Set - Green [30cm]

SKU:	Qty:
NG HY923030G NHSSC	23x31x10cm



Dustpan & Brush Set - Yellow [30cm]

SKU:	Qty:
NG HY923030Y NHSSC	23x31x10cm

Heavy Duty Floor Squeegee [55cm]

A professional, 55cm plastic squeegee with two foam rubber blades, ideal for fast cleaning and drying of all hard floors.

Handles - See pages 34 to 35

- Features:**
- Available in four colours for easy colour coding.
 - Fitting suitable for handles with 25mm diameter.



Heavy Duty Floor Squeegee Red [55cm]

SKU:	Qty:
NG HY923028-R NHSSC	23x31x10cm



Heavy Duty Floor Squeegee Blue [55cm]

SKU:	Qty:
NG HY923028-B NHSSC	23x31x10cm



Heavy Duty Floor Squeegee Green [55cm]

SKU:	Qty:
NG HY923028-G NHSSC	23x31x10cm



Heavy Duty Floor Squeegee Yellow [55cm]

SKU:	Qty:
NG HY923028-Y NHSSC	23x31x10cm

Safety Sign - Wet Floor / Cleaning in Progress

A great value double sided A frame sign to warn against potential hazards from wet floor surfaces during and after cleaning or spillages.

- **Features:**
- - Made from vivid yellow plastic
- - No assembly needed
- - Folds flat for easy storage.
-
-



Safety Sign - Wet Floor /
Cleaning in Progress

SKU:	Qty:
NG SG911001 NHSSC	62x30cm

Safety Sign - Cleaning in Progress / Cleaning in Progress

A great value double sided A frame sign to warn against potential hazards from wet floor surfaces during and after cleaning or spillages.

- **Features:**
- - Made from vivid yellow plastic
- - No assembly needed
- - Folds flat for easy storage.
-
-



Safety Sign - Cleaning in
Progress / Cleaning in Progress

SKU:	Qty:
NG SG911003 NHSSC	62x30cm

Safety Sign – Wet Floor / Wet Floor

A great value double sided A frame sign to warn against potential hazards from wet floor surfaces during and after cleaning or spillages.



- **Features:**
- – Made from vivid yellow plastic
- – No assembly needed
- – Folds flat for easy storage.
-
-
-

Safety Sign – Wet Floor / Wet Floor

SKU:		Qty:	
NG	SG911005		
NHSSC			62x30cm



Have a question? Call on 01726 813979 or email us at hello@ninegrp.com – we're happy to help!



Have a question and would like a virtual demo?

We can do that, schedule a time that works for you and we'll explore solutions together.

www.ninegrp.com/livedemo or call **01726 813919**



SCAN TO BOOK

TTS **Lampo System**

www.innegr.com/tts-handles-and-frames

One handle, many tools. Total efficiency.

The Lampo System with Plug device enhances hygiene in healthcare settings by allowing frames to be placed and removed without hand contact.

- Reduces cross-contamination
- Streamline workflows
- Maximizes equipment capacity

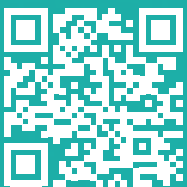

Call us
**01726
813979**

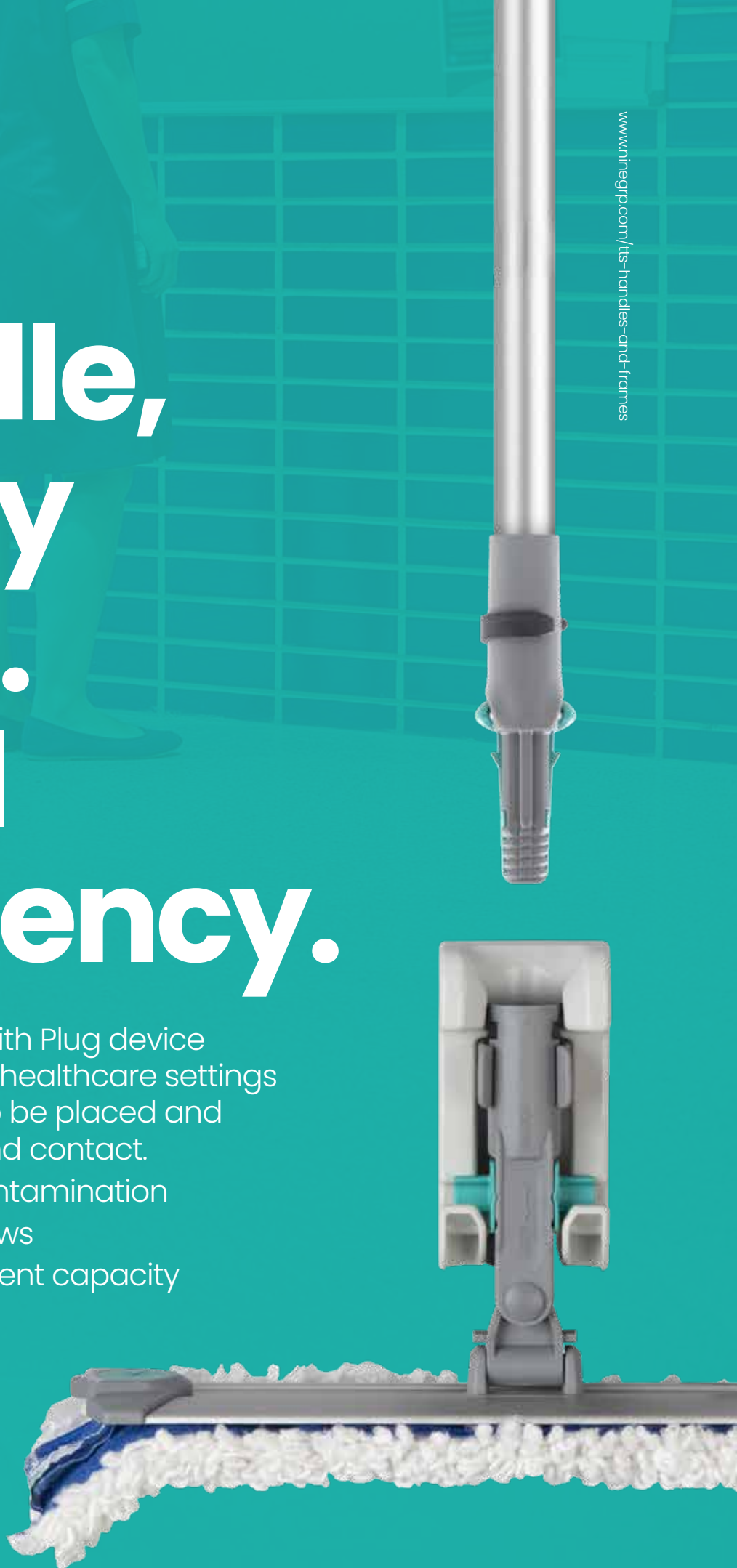



Dusting

Dust Beater, Frame & Handle [60cm] Blue

Lightweight for ease of use for efficient and effective dust control.

- **Features:**
- – Lightweight for ease of use
- – Replacement components are available.
- – Pack contents:
 - Handle Hygiene 137cm
 - Sweeper Mop Frame 60cm
 - Sweeper Mop Head Synthetic 60cm

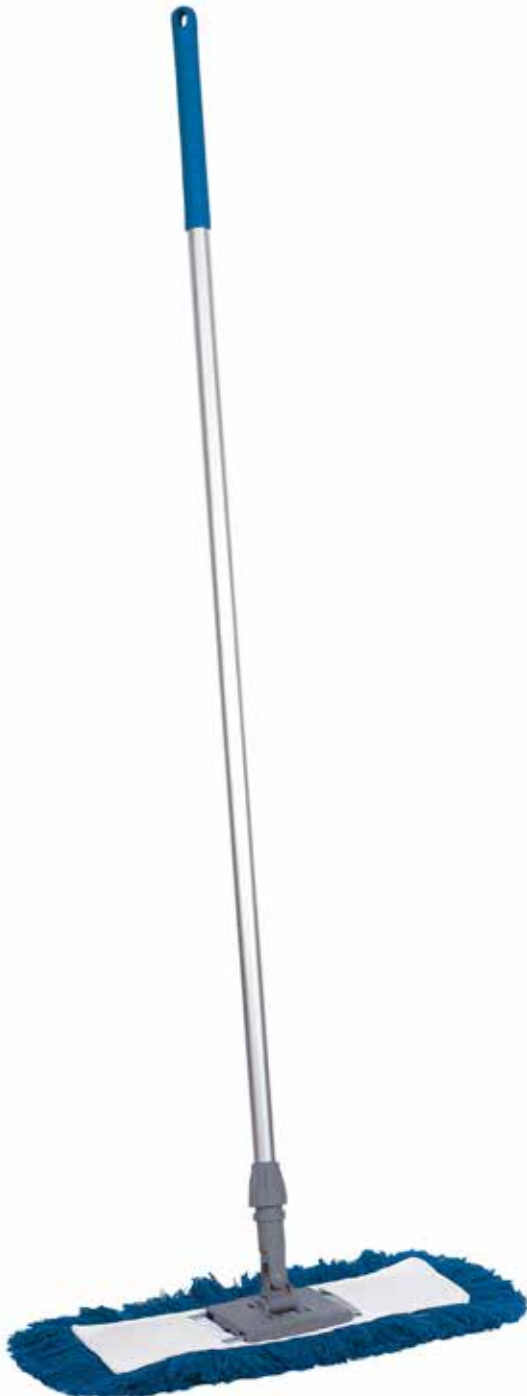

Dust Beater, Frame and Handle [60cm] - Blue

SKU:		Size:
NG	HY925042-60-B	60cm x 11cm
NHSSC		

TTS – Lamello Lampo

Lamello Lampo frame with rubber blades and clips to hold gauzes, with Jack Lampo for ø 23 mm handles. Dusting system with gauzes or antistatic cloths. Ideal for high-performance professional cleaning.

Handles – See pages 37 & 38

Dusting Cloth – See page 179

Compatible Cloths – See pages 140 to 148



Features:

- Effective: rubber blades stick to surfaces for better dust collection
- Hygienic: closed-cell rubber blocks dirt and bacteria buildup
- Shock-resistant: reinforced with ribs for durability
- Versatile: works with any cloth or gauze via universal clips
- Efficient: Lampo system allows the same handle to be used with the range of tools

TTS Lamello Lampo Frame
With Block [40cm] For Use With
Disposable Dusting Cloth

– Includes Jack Lampo

SKU:

Size:

NG **12040421-40**

NHSSC **MKO85628**

40cm x 11cm

TTS Lamello Lampo Frame
With Block [60cm] For Use With
Disposable Dusting Cloth

– Includes Jack Lampo

SKU:

Size:

NG **12040421-61**

NHSSC **MKO85625**

60cm x 11cm



Wanting a bespoke trolley to actually meet your needs?
Book a time to see your own configuration on **01726 813979**
or email us at virtual@ninegrp.com

TTS – Lamello Frame

Frame with rubber blades and clips to hold gauzes for dusting. Dusting system with gauzes or antistatic cloths. Ideal for high-performance professional cleaning.

Handles – See pages 37 & 38

Dusting Cloth – See page 179

Compatible Cloths – See pages 140 to 148

- **Features:**
- – Effective: rubber blades stick to surfaces for dust collection
- – Hygienic: closed-cell rubber blocks dirt and bacteria
- – Handy: easy to clean, autoclave-safe, hospital-ready
- – Shock-resistant: ribbed design adds strength
- – Versatile: fits any cloth or gauze with universal clips
- – Flexible: 360° joint for use in tight spaces



TTS – Lamello Frame, [40cm] For Use With Disposable Dusting Cloth

SKU:		Size:
NG	12040420-40	40cm x 11cm
NHSSC	MKB85285	

TTS – Lamello Frame, [60cm] For Use With Disposable Dusting Cloth

SKU:		Size:
NG	12040420-60	60cm x 11cm
NHSSC	MKB85228	

TTS Mini telescopic handle [Grey]

Aluminium telescopic handle with hole, non-slip ergonomic grip and coloured cap. Aluminium telescopic handle. Ideal for vertical cleaning in narrow spaces.

- **Features:**
- – Non-slip grip: rubber inserts grant a very good grip and to lean it safely against the wall
- – Colour coded: it is possible to code by colour the handles thanks to the plastic caps



Clean Glass Mini Telescopic Handle [Grey]

Use with switchable colour coded caps

SKU:		Size:
NG	12040320	56 to 93cm [L]
NHSSC	MKO85227	
		ø 2.3cm [Int]

TTS – Bendy Frame

Flexible duster inclining up to 270°, with universal clip and Lampo system handle with removable cap. System with flexible duster. Ideal to clean rounded, irregular or narrow surfaces.

Can be used with telescopic handle or Italian threaded pole to reach high-up surfaces.

Handles - See pages 37, 38 & 174

Cloths - See pages 177 & 178



Features:

- Easy: easy to shape support
- Time-saving: thanks to a larger surface in comparison with manual wiping
- Reduce strain: it allows to clean hard-to-reach surfaces
- Hygienic: closed-cell rubber prevents dirt and bacteria from collecting
- Easy to maintain: cleaning of the tool is very easy and fast
- Versatile: to be used with the convenient mops or with disposable cloths, thanks to the universal clip

60cm (Lampo connection compatible) Flexible rubber bends to fit surface cleaned, both sides dusting using Microfibre Heads angle adjustable 270°

- Jack Lampo not included.

SKU:

Size:

NG **12040430**
NHSSC **MKO85154**

60cm x 6cm

TTS – BIT Frame

Duster inclining up to 270° with universal clips and Lampo system handle with removable cap. System with foldable duster. The best solution for a quick and precise cleaning of hard-to-reach surfaces with regard to highness, depth or inclination.

Can be used with telescopic handle or Italian threaded pole to reach high-up surfaces.

Handles - See pages 37, 38 & 174

Cloths - See pages 177 & 178



Features:

- Versatile: to be used with the convenient mops or with disposable cloths, viscose or antistatic, thanks to the universal clips
- Time-saving: thanks to a larger surface in comparison with manual wiping
- Effective: the stiff structure allows a constant pressure on the whole length
- Reduce strain: it allows to clean hard-to-reach surfaces

60cm (Lampo connection compatible) Stiff structure allows constant pressure along the length of the frame, both sides dusting using Microfibre Heads angle adjustable 270°

- Jack Lampo not included.

SKU:

Size:

NG **12040431**
NHSSC **MKO85205**

60cm x 7cm

TTS Buffy [Acrylic U-Opening Duster]

Acrylic u-opening duster, inclining up to 240° and Lampo system handle with removable cap. Foldable duster for manual dusting. The best solution for a quick and precise cleaning of hard-to-reach surfaces with regard to highness, depth or inclination. (Lampo connection compatible).

Handles - See pages 37, 38 & 174



Features:

- Effective: the natural electrostatic action that is generated by rubbing acrylic fibres on the surfaces makes them ideal for dusting
- Practical: U-shaped fitting enables even difficult-to-reach surfaces to be accessed with ease
- Versatile: practical button-operated system enables duster to be adjusted up to 240°
- Safe: the coupling system for replacement duster ensures it is securely fixed while cleaning

TTS - Buffy Wrap Around U Shape Frame [Lampo Connection Compatible]

- Jack Lampo not included.

Foldable U opening duster, both sides dusting using Acrylic Mop Head Angle adjustable 24°

SKU:	Size:
NG 12040274 NHSSC MKB85293	40cm x 8cm

TTS Buffy Acrylic Head

Acrylic mop head for Buffy duster. Foldable duster for manual dusting. The best solution for a quick and precise cleaning of hard-to-reach surfaces with regard to highness, depth or inclination.

Compatible Head - See above



Features:

- Effective: the natural electrostatic action that is generated by rubbing acrylic fibres on the surfaces makes them ideal for dusting
- Washing temperature max 40°C

TTS - Buffy Acrylic Head

SKU:	Size:
NG 12040259 NHSSC MKB85273	41cm

TTS Bendy & Bit Acrylic Mop Head

Acrylic mop head for Bendy and Bit frames. System with flexible or foldable duster. The best solution for a quick and precise cleaning of hard-to-reach surfaces with regard to highness, depth or inclination.

Frame - See page 175



Features:

- Effective: the natural electrostatic action that is generated by rubbing acrylic fibres on the surfaces makes them ideal for dusting
- Washing temperature max 40°C

TTS - Bendy and Bit Acrylic Mop Head 60cm

SKU:

Size:

NG **12040258**

NHSSC **MKB85294**

60cm x 8cm

TTS Bendy & Bit Microfibre Mop Head

Microfibre mop head for Bendy and Bit frames. System with flexible or foldable duster. The best solution for a quick and precise cleaning of hard-to-reach surfaces with regard to highness, depth or inclination.

Frame - See page 175



Features:

- Washing temperature max 60°C

TTS - Bendy and Bit Microfibre Mop Heads 60cm Blue

SKU:

Size:

NG **12040257-02**

NHSSC **MKB85230**

60cm x 8cm



TTS - Bendy and Bit Microfibre Mop Heads 60cm White

SKU:

Size:

NG **12040257-05**

NHSSC **MKB85252**

60cm x 8cm

TTS Disposable Impregnated Cloth Sleeves For BENDY and BIT [60cm]

Disposable cloth with glue for dusting for Bently and Bit dusters. System with flexible or foldable duster. The best solution for a quick and precise cleaning of hard-to-reach surfaces with regard to highness, depth or inclination

Frame - See page 175

⋮ **Features:**

- ⋮ - Special finish: TNT fibres are coated with a viscous, glue-like substance, capturing even the smallest dust
- ⋮ - Effective: the special glue coating collects dirt reducing the moving of bacteria among the different areas and leaving no oily residue
- ⋮ - Disposable: greatest control of cross contamination
- ⋮ - Very low friction: fibres glide on surfaces without friction

TTS - Disposable Impregnated Cloth Sleeves For BENDY and BIT [60cm] Suitable for most high reach dusting devices - Pack of 12



SKU:	Qty:
NG 11040531-60	Pack of 12
NHSSC MKO85627	



The smart choice for high-performance & professional cleaning.

Lemon 5L
19041015
MKM85035

Lemon 1L Dosing Bottle
19041013
MKM85037

See page 159

TTS Lamello Disposable Cloth for Dusting [x400 sheets]

Disposable cloth with glue for dusting for Lamello system. Dusting system with gauzes or antistatic cloths. Ideal for high-performance professional cleaning.

Compatible Frames - See pages 173 & 174



Features:

- Effective: the special glue coating collects dirt reducing the moving of bacteria among the different areas and leaving no oily residue
- Disposable: greatest control of cross contamination
- Very low friction: fibres glide on surfaces without friction

TTS - Lamello Disposable Cloth for Dusting [x400 sheets]

SKU:

Qty:

NG	11040520	400 Sheets
NHSSC	MKC85391	

TTS - Dry Dusting Antistatic Cloths [60cm x 30cm] Pack of 50

White polypropylene cloths, impregnated with non-toxic and odourless mineral oil, packed. System with flexible or foldable duster.

The best solution for a quick and precise cleaning of hard-to-reach surfaces with regard to highness, depth or inclination. To be used with sponge and Lamello frames 40, 60 and 80 cm

Compatible Frames - See pages 173 & 174



Features:

- Disposable: greatest control of cross contamination
- Effective: the oily finish of the cloths collects dirt reducing the moving of bacteria among the different areas and leaving no oily residue
- Very low friction: fibres glide on surfaces without friction

TTS - Dry Dusting Antistatic Cloths - [60cm x 30cm] - Pack of 50

SKU:

Qty:

NG	11040535-6030	Pack of 50
NHSSC	MKC85569	

The perfect partner...

Uni9 Glass Cleaner Instant Clear - 750ml

NG **19041040**

NHSSC **MKJ85473**

See page 95



Glass Cleaning

TTS Clean Glass Pro Kit

PRO Kit for mirrors, glasses and stainless steel cleaning. Frame with strap tape system and ultra-microfibre cloth for cleaning of shiny surfaces. Ideal for cleaning shiny surfaces in interiors such as display cases in refrigerated counters and food stores, glass doors.

- Features:**
- It reduces by one third the time: cleans and dries at once
 - Ergonomic: lightweight, it reduces operator's strain
 - Long durability: stainless material, guarantees a long product life
 - Efficient: the Lampo System allows the same handle to be used with the whole range of surface cleaning products, hooking them up and detaching them in a flash

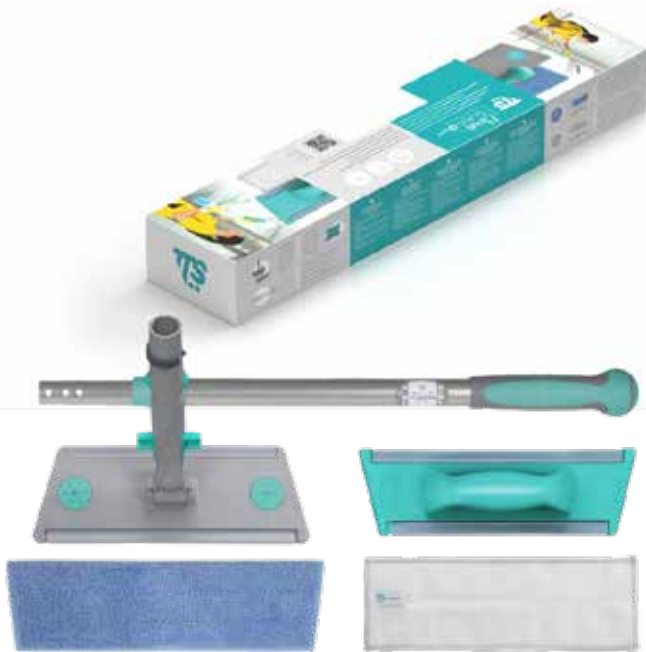

TTS Clean Glass – Pro Kit

Includes Lampo Hand Frame, Mini Frame with wall lock, telescopic handle, 2x Shiny Pads, 1x General Pad

SKU:	Size:
NG 12040300	56.5x12x7cm
NHSSC MKO85211	

TTS Clean Glass Mini telescopic handle [Grey]

Aluminium telescopic handle with hole, non-slip ergonomic grip and coloured cap. Aluminium telescopic handle. Ideal for vertical cleaning in narrow spaces.

- Features:**
- Non-slip grip: rubber inserts grant a very good grip and to lean it safely against the wall
 - Colour coded: it is possible to code by colour the handles thanks to the plastic caps

Compatible Frames – See page 183

Clean Glass Mini Telescopic Handle [Grey]

Use with switchable colour coded caps



SKU:	Size:
NG 12040320	56 to 93cm [L] ø 2.6cm [Ext] ø 2.3cm [Int]
NHSSC MKO85227	

TTS Clean Glass Velook Mini Frame with Wall Lock [Grey]

Frame with Velook System [Strap Tape System] with universal clips and Block System. Flat mopping system with frame with Velook System, to be used either pre-soaked, soaked on demand with soaking station or with handles with tank. Ideal for professional and high performance cleaning of horizontal and vertical surfaces.

Handles - See pages 37, 38 & 182
Glass Cloths - See pages 183 to 185



Features:

- Easy: mop changing is easy and quickly
- Ergonomic: it is the most lightweight system of TTS range
- Multi Purpose: Use with cloths, pads or disposables

TTS - Clean Glass Velook Mini Frame with Wall Lock - Grey

Use with cloths, pads or disposables

SKU:

Size:

NG	12040302	56.5x12x7cm
NHSSC	MKO85238	

TTS Clean Glass Gloss Surface / Glass Cleaning Pad [30cm]

Microfibre cloths for smooth surfaces. Frame with Velook System and ultra-microfibre cloth for cleaning of shiny surfaces. Ideal for cleaning shiny surfaces in interiors such as display cases in refrigerated counters, food stores and glass doors.

Compatible Frame - See above



Features:

- Washing temperature max 95°C, recommended 60°C
- It reduces by one third the time: cleans and dries at once

TTS - Clean Glass gloss surface / Glass cleaning pad, 30cm Microfibre, Velook Type Grey textile only

SKU:

Size:

NG	12040351	30cm
NHSSC	MKO85164	

TTS Clean Glass Micro Blue General Cleaning Pad [30cm]

Microfibre flat mop, highly absorbent, with Velook System support. Flat mopping system with pockets, to be used either pre-soaked, soaked on demand with soaking station or with handles with tank. Ideal for recurring washing of smooth surfaces.

Compatible Frame - See page 183



- Features:**
- Washing temperature max 90°C, recommended 60°C
 - Easy: mop changing is easy and quick
 - Highest hygiene: microfibre penetrates into the microporosity of the floor, collecting dirt and more than 95% of bacteria
 - Long durability: high quality strap tape to ensure a long life of the mop

TTS - Clean Glass Micro Blue General Cleaning Pad, 30cm Microfibre
Velook Type Blue textile with removeable colour coded tabs

SKU:	Size:
NG 12040352-02 NHSSC MKC85383	30cm

TTS Clean Glass Microsafe Ingrained Dirt Cleaning Pad [30cm]

Microfibre flat mop for non-slip floors and removal of ingrained dirt, with Velook System support. Flat mopping system with frame with Velook System, to be used either pre-soaked, soaked on demand with soaking station or with handles with tank. Ideal for washing of non-slip or porous surfaces, suitable to remove ingrained dirt.

Compatible Frame - See page 183



- Features:**
- Washing temperature max 90°C, recommended 60°C
 - Easy: mop changing is easy and quick
 - Highest hygiene: microfibre penetrates into the microporosity of the floor, collecting dirt and more than 95% of bacteria
 - Long durability: high quality strap tape to ensure a long life of the mop

TTS - Clean Glass Microsafe ingrained dirt cleaning pad, 30cm Microfibre with abrasive action
Velook Type Blue textile with removeable colour coded tabs

SKU:	Size:
NG 12040353-02 NHSSC MKC85384	30cm

TTS Clean Glass

Microsplit 32 Looped Deep Cleaning Pad [30cm]

Ultramicrofibre flat mop looped end with Velook System support. Flat mopping system with frame with Velook System, to be used either pre-soaked, soaked on demand with soaking station or with handles with tank. Ideal for any surface and for particle dirt thanks to the high dirt collection power of yarn and microfibre.

Compatible Frame - See page 183



Features:

- Washing temperature max 90°C, recommended 60°C
- Easy: mop changing is easy and quick
- Highest hygiene: microfibre penetrates into the microporosity of the floor, collecting dirt and more than 95% of bacteria
- Long durability: high quality strap tape to ensure a long life of the mop

TTS - Clean Glass Microsplit32
Looped Deep Cleaning Pad, 30cm
Ultra Microfibre, Looped

Velook Type Blue textile with removeable colour coded tabs

SKU:

Size:

NG	12040354-12	30cm
NHSSC	MKC85378	

TTS Clean Glass

Microriccio Looped Deep Cleaning Pad [30cm]

Microfibre flat mop looped end with Velook System support. Flat mopping system with frame with Velook System, to be used either pre-soaked, soaked on demand with soaking station or with handles with tank. Ideal for any surface and for particle dirt thanks to the high dirt collection power of yarn and microfibre.

Compatible Frame - See page 183



Features:

- Washing temperature max 90°C, recommended 60°
- Long durability: high quality strap tape to ensure a long life of the mop
- Easy: mop changing is easy and quick
- Highest hygiene: microfibre penetrates into the microporosity of the floor, collecting dirt and more than 95% of bacteria

TTS - Clean Glass Microriccio
Looped Deep Cleaning Pad, 30cm
Microfibre, Looped

Velook Type Blue textile with removeable colour coded tabs

SKU:

Size:

NG	12040355-12	30cm
NHSSC	MKC85387	

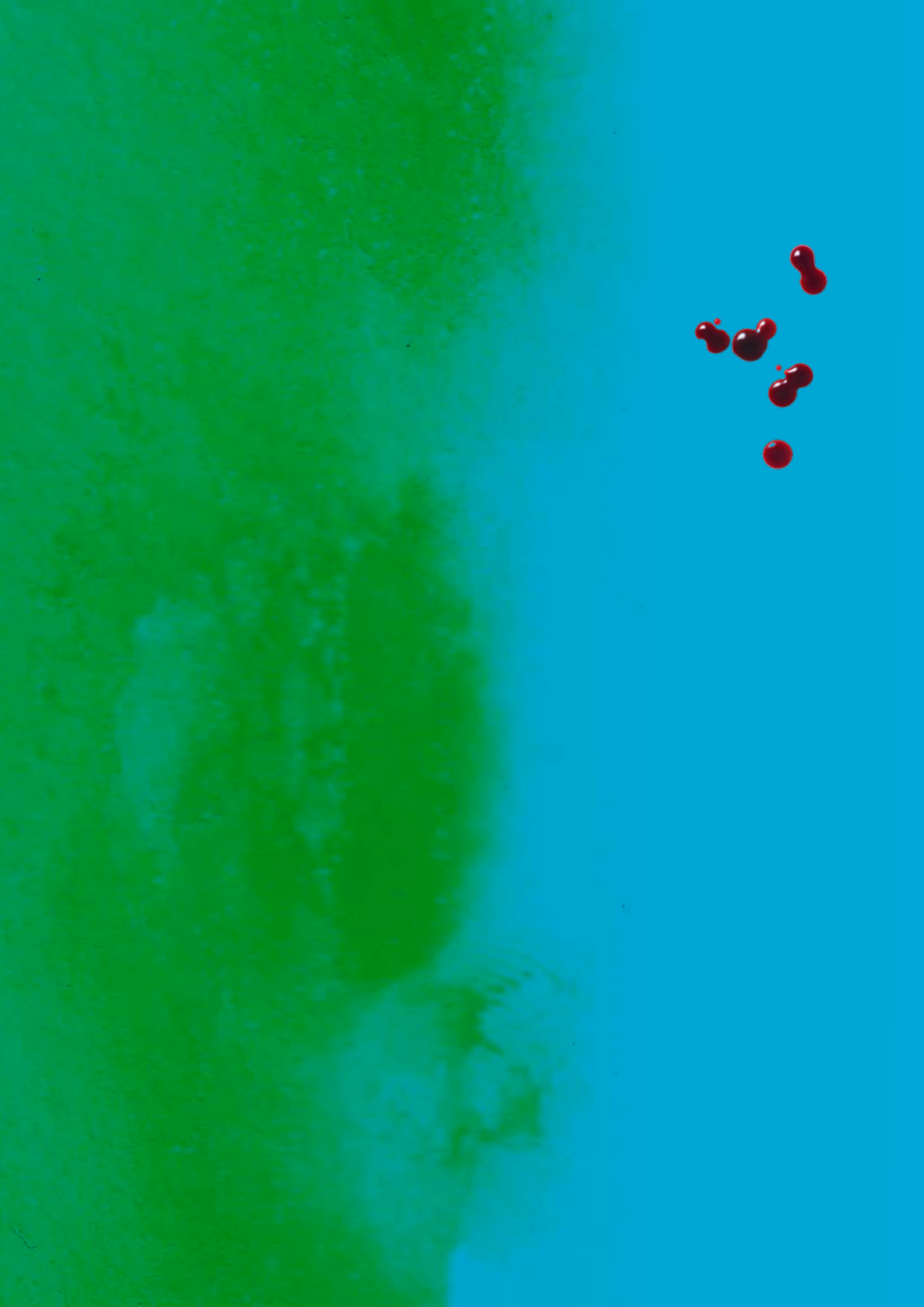

Spill Kits

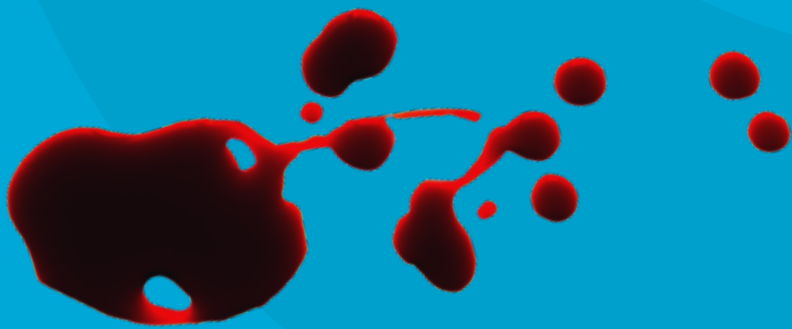

Uni9 Blood Spill Kit

The Uni9 Blood Spill Pack is a comprehensive, single-use kit designed for the safe, rapid, and effective management of blood spills. Ideal for healthcare, education, workplace, and public environments, this pack ensures compliance with infection control standards and provides all necessary materials for containment, disinfection, and disposal in one compact, easy-to-use kit.

Features:

- Fast & Effective
- Simply shake granules onto spill area, allow to gel and then dispose of via hazardous waste
- All items disposed of in clinical waste sack
- Suitable for blood
- Small & compact
- Pack produced in collaboration with NHSSC



Uni9 Spill Kit Pack for Blood

Kit Contents:

- 1x 100ml sachet With Nadcc Granules
- 4x Chlorine Tablets
- 2 x Paper Towels
- 1x Pair Large Gloves
- 1x Apron
- 1x Clinical Waste Sack
- 1x Cable Tie
- 1x Scoop & Scraper
- 1x Instruction Sheet

SKU:

Size:

NG	13040120
NHSSC	MK085242

Standard Kit



Have a question? Call on 01726 813979 or email us at hello@ninegrp.com – we're happy to help!



Watch in action

ninegrp.com/video-hub-medi9



Uni9 Spill Kit For Blood & Urine in Case

The Uni9 spill kit for blood and urine, includes both the Uni9 blood spill pack and the Medi9 Superabsorb Universal Spill Kit, a comprehensive, single-use solution for the safe, rapid, and effective management of blood and body fluid spills. The Medi9 Superabsorb Universal Spill Kit can be used on all body fluid spills. This kit is designed for use in healthcare, education, workplace, and public environments, ensuring compliance with infection control standards and providing all necessary materials for containment, disinfection, and safe disposal in one convenient, sealed pouch.

Features:

- Safe to use in any environment
- Fragrance free / No odour Medi9 Kit
- Simply shake granules onto spill area, allow to gel and then dispose of via hazardous waste
- All items disposed of in clinical waste sack
- Suitable for blood, urine, diarrhoea, vomit and many other liquid type spills.
- Pack produced in collaboration with NHSSC



Uni9 Spill Kit For Blood & Urine in Case

Case Contents:

- 2x Blood Spill Packs*
- 2x Vomit/Urine Spill Packs**
- 2x Instruction Sheet
- 1x Record Sheet

*Kit 1 (Uni9 Blood) Contents:

- 1x 100ml sachet With Nadcc Granules
- 4x Chlorine Tablets
- 2x Paper Towels
- 1x Pair Large Gloves
- 1x Apron
- 1x Clinical Waste Sack
- 1x Cable Tie
- 1x Scoop & Scraper
- 1x Instruction Sheet

**Kit 2 (Medi9 Spill Kit) Contents:

- 1x 40g Superabsorb Sachet
- 4x Universal Wipes (2x per sachet)
- 2x Nitrile Gloves
- 1x Apron
- 1x Clinical Waste Sack
- 1x Cable Tie
- 1x Scoop Scraper
- 1x Instruction Sheet



SKU:

Size:

NG **13040122**
NHSSC **MKO85225**

Case Kit

Does exactly what it says on the label...

- Quickly freshens an area
- Can be used in almost any area
- Fast & effective
- Biodegradable



Uni9 Air Freshener

**Client feedback is they absolutely love it...
astronomical results... love the scent!**



Uni9 Air Freshener
Trigger Spray - 750ml

NG **19041034** / NHSSC **MKJ85465**

See page 95

Medi9 Superabsorb Spill Granules / Clean-up Powder



Watch in action

ninegrp.com/video-hub-medi9

Medi9 Superabsorb is a superabsorbent polymer specifically engineered for absorption and retention of fluids associated with the healthcare industry.

Medi9 Superabsorb is a swellable, in-soluble, cross-linked polymer, packaged as a white, granular product in its dry form. Upon contact with fluids, a gel is formed. The resulting gel, with excellent mechanical stability, retains these fluids well, even under stress, since the absorption is based on a physical-chemical process.

- Features:**
- Safe to use in any environment
 - Fragrance free / No odour
 - Suitable for all body fluids
 - Simply apply to body fluid, allow to gel and then dispose of via hazardous waste
 - Ready to Use (RTU)



Medi9 [10kg] Bucket & Scoop

SKU:	Size:
NG 11040038 NHSSC	10kg



Medi9 [475g] Shaker Tub

SKU:	Size:
NG 11040024 NHSSC HDV85015	475g



Medi9 [5kg] Bucket & Scoop

SKU:	Size:
NG 11040036 NHSSC	5kg

Medi9 [360g] Shaker Tub

SKU:	Size:
NG 11040022 NHSSC HDV85016	360g

Medi9 [1.5kg] Bucket & Scoop

SKU:	Size:
NG 11040030 NHSSC	1.5kg

Medi9 [240g] Shaker Tub

SKU:	Size:
NG 11040020 NHSSC	240g



Medi9 Universal Spill Kits

The one Kit for all body fluid Spills

Medi9 Superabsorb Spill Kits are suitable for a variety of spills including all body fluids and other biohazards.

Packaged into individual disposable kits, these units contain everything required to handle a spill. Non chlorine-based, odour-free, non-toxic, they are safe to use in any environment, including food preparation areas. The pack provides PPE and cleaning materials for both containment and disposal in one unit.

Features:

- Safe to use in any environment
- Fragrance free / No odour
- Simply shake granules onto spill area, allow to gel and then dispose of via hazardous waste
- All items disposed of in clinical waste sack
- Suitable for blood, urine, diarrhoea, vomit and many other liquid type spills.



Medi9 Universal Spill Kit

Standard Kit Content:

- 1x 40g Superabsorb Sachet
- 4x Universal Wipes (2x per sachet)
- 2x Nitrile Gloves
- 1x Apron
- 1x Clinical Waste Sack
- 1x Cable Tie
- 1x Scoop Scraper
- 1x Instruction Sheet

SKU:

Size:

NG **18041206**

NHSSC **MKO85167**

Standard Kit



Medi9 Universal Spill Kit+

Plus Kit Content:

- 1x 30ml Medi9 Surface Spray
- 1x 40g Superabsorb Sachet
- 4x Universal Wipes (2x per sachet)
- 2x Nitrile Gloves
- 1x Apron
- 1x Clinical Waste Sack
- 1x Cable Tie
- 1x Scoop Scraper
- 1x Instruction Sheet

SKU:

Size:

NG **18041208**

NHSSC **MKO85226**

Standard Kit Plus



Have a question? Call on 01726 813979 or email us at hello@ninegrp.com – we're happy to help!

Medi9 Universal Spill Pad Kit

Medi9 Superabsorb Spill Pad Kits are suitable for a variety of spills including body fluids and other biohazards.

These kits are Non chlorine-based, odour-free, non-toxic and are safe to use in any environment, including food preparation areas. The kit additionally contains two wipe sachets to disinfect the area once the spill has been removed.

Features:

- Safe to use in any environment
- Fragrance free / No odour
- Generous size pad
- Suitable for blood, urine, diarrhoea, vomit and many other liquid type spills.



Medi9 Universal Spill Pad Kit

Content:

- 1 x Large Inert Soak Up Pad
- 2 x Large Wipes (2 Sachets)

SKU:

Size:

NG	18041216	Standard Kit
NHSSC	MK085182	

Medline Double Sided Absorbent Disposable Floor Pad – 75cm x 38cm – 7L

Medline’s Double-Sided Absorbent Floor Pad provides a single-use, safe and hygienic solution for easily retaining fluids, and is useful in areas where fluids accumulate, like operating theatres (around or under operating tables); scrub sinks surroundings, and examinations, decontamination or sterilisation rooms.

Features:

- Promote hygiene with a high-absorbency pad
- Speed up the cleaning process and absorb fluid spills on the floor
- Do not stand on



For use in theatres, maternity units and areas where large body fluid spills occur.

Medline Double Sided Absorbent Disposable Floor Pad – 75cm x 38cm – 7L Capacity – Pack of 50

SKU:

Qty

NG	11040097	Pack of 50
NHSSC	MKJ85787	



Medline **Liqui-Loc Anti Slip Absorbent Disposable Floor Mat / Pad - 71cm x 102cm - 2.2L**

Medline's LIQUI-LOC™ Anti-Slip Absorbent Floor Mat provides a safer environment by lowering the risk of infections and slips due to spills. Each is a single-use, absorbent anti-slip floor mat.

Features:

- Impervious anti-slippery back
- Drip-safe, locking fluids to avoid cross-contamination and complicated handling
- Easy disposal for hygiene and safety

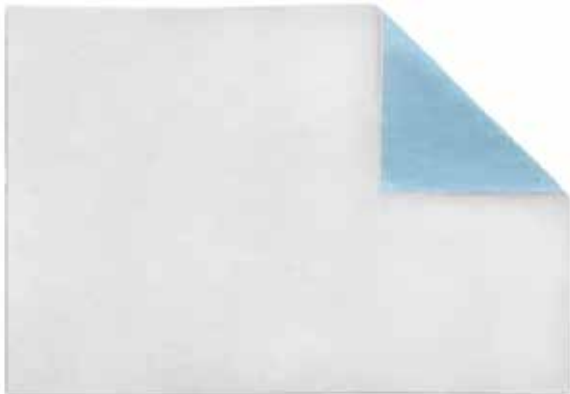

For use in theatres, maternity units and areas where large body fluid spills occur.

Medline Liqui-Loc Anti Slip Absorbent Disposable Floor Mat / Pad - 71cm x 102cm - 2.2L Capacity - Pack of 13

SKU:	Qty
NG 11040096-102 NHSSC MKJ85794	Standard Kit

Medline Liqui-Loc Anti Slip Absorbent Disposable Floor Mat / Pad - 71cm x 142cm - 3L Capacity - Pack of 10

SKU:	Qty
NG 11040096-142 NHSSC MKJ85784	Standard Kit



Medline Liqui-Loc Anti Slip Absorbent Disposable Floor Mat / Pad - 71cm x 183cm - 3.9L Capacity - Pack of 8

SKU:	Qty
NG 11040096-183 NHSSC MKJ85783	Standard Kit

**You'll find your
perfect bins to put
those gloves in...**

See pages 201 to 211



Gloves/PPE

Nitrile Blue Glove [Powder Free]

Medical grade high performance, powder-free, single-use disposable gloves suitable for most and hygiene tasks. They are gentle on the hands, yet durable. Ideal for cleaning, chemical handling, care home work, catering, food processing, and automotive engineering and maintenance.

- **Features:**
- – Single use
- – Box of 200
- – Medical Grade



Nitrile Blue Glove,
Powder Free,
Small - Box 200

SKU:		Qty:
NG	16050030-03	200
NHSSC	BCZ85149	

Nitrile Blue Glove,
Powder Free,
Medium - Box 200

SKU:		Qty:
NG	16050030-04	200
NHSSC	BCZ85148	

Nitrile Blue Glove,
Powder Free,
Large - Box 200

SKU:		Qty:
NG	16050030-05	200
NHSSC	BCZ85147	

Nitrile Blue Glove,
Powder Free,
X-Large - Box 180

SKU:		Qty:
NG	16050030-06	180
NHSSC	BCZ85145	

Stockinette Glove [Single]

Soft cotton gloves for multi purpose usage. Made from 100 percent soft cotton material. It can be used to comfort and protect sore or dry hands.



- Features:**
- May be worn on either hand
 - Wash in warm soapy water and allow to dry naturally
 - 100% Cotton gloves

Stockinette Glove - Each

SKU:	Qty:
NG 16050095-12	Each
NHSSC BCZ85146	

One Simple Kit.

Suitable for all body fluids [including Urine, Vomit & Blood].

- ✓ **Reduce Inventory**
- ✓ **Reduce Cost**
- ✓ **Reduce Human Error**

Medi9 Universal Spill Kit **MKO85167**

See page 193





Bins

TTS Derby Bin with Pedal Operated Lid 60L [XL]

Bin with pedal and lid, with odour eliminating cartridge box and bag tightener. Waste collection bin ideal for any environments. Colour coded lids ideal for separate waste collection. We recommend 70x110cm standard garbage bags in the 60L version and 50x70cm in the version with 2x30L insert. In compliance with the H.A.C.C.P. regulation, that require bins avoiding any contact with the hands and are easy to clean and disinfect.

Features:

- Hygienic: thanks to the pedal, it can be used without any hand contact
- Anti-odour: lid provided with odour eliminating cartridge box
- Efficient: 2x30L insert to set up practical departments, in which different types of waste can be disposed of, encouraging its recycling
- Ideal to create zones of separate waste collection thanks to the colour-coded lids



TTS - Derby bin Red with pedal operated lid 60L

SKU:	Size:
NG 12040053-01 NHSSC MMB85071	60L



TTS - Derby bin Blue with pedal operated lid 60L

SKU:	Size:
NG 12040053-02 NHSSC MMB85091	60L



TTS - Derby bin Green with pedal operated lid 60L

SKU:	Size:
NG 12040053-03 NHSSC MMB85088	60L



TTS - Derby bin Yellow with pedal operated lid 60L

SKU:	Size:
NG 12040053-04 NHSSC MMB85086	60L



TTS - Derby bin White with pedal operated lid 60L

SKU:	Size:
NG 12040053-05 NHSSC MMB85067	60L



Wanting a bespoke trolley to actually meet your needs? Book a time to see your own configuration on **01726 813979** or email us at **virtual@ninegrp.com**

TTS Derby Bin with Pedal Operated Lid 90L [XXL]

Bin with pedal and lid, with odour eliminating cartridge box and bag tightener. Colour coded lids ideal for separate waste collection. We recommend 80x110cm standard garbage bags in the 90L version and 70x110cm in the version with 2x45L insert. In compliance with the H.A.C.C.P. regulation, that require bins avoiding any contact with the hands and are easy to clean and disinfect.



Features:

- Hygienic: thanks to the pedal, it can be used without any hand contact
- Anti-odour: lid provided with odour eliminating cartridge box
- Efficient: 2x45L insert to set up practical departments, in which different types of waste can be disposed of, encouraging its recycling
- Ideal to create zones of separate waste collection thanks to the colour-coded lids



TTS – Derby bin Red with pedal operated lid 90L

SKU:	Size:
NG 12040054-01 NHSSC MMB85074	90L



TTS – Derby bin Blue with pedal operated lid 90L

SKU:	Size:
NG 12040054-02 NHSSC MMB85081	90L



TTS – Derby bin Green with pedal operated lid 90L

SKU:	Size:
NG 12040054-03 NHSSC MMB85073	90L



TTS – Derby bin Yellow with pedal operated lid 90L

SKU:	Size:
NG 12040054-04 NHSSC MMB85062	90L



TTS – Derby bin White with pedal operated lid 90L

SKU:	Size:
NG 12040054-05 NHSSC MMB85063	90L

TTS Lindy Bin with Swing Lid 25L

25L with coloured swing lid waste collection bin.
 Ideal for any environments. Colour coded lids ideal for separate waste collection. We recommend 50x60cm standard garbage bags.

- Features:**
- Discrete: the swing lid avoids seeing the content of the bin
 - Easy to maintain: the smooth surfaces and the absence of cavities facilitate cleaning and guarantee a high level of hygiene



TTS – Lindy bin with Red swing lid

SKU:	Size:
NG 12040059-01	25L
NHSSC MMB85085	



TTS – Lindy bin with Blue swing lid

SKU:	Size:
NG 12040059-02	25L
NHSSC MMB85082	



TTS – Lindy bin with Green swing lid

SKU:	Size:
NG 12040059-03	25L
NHSSC MMB85093	



TTS – Lindy bin with Yellow swing lid

SKU:	Size:
NG 12040059-04	25L
NHSSC MMB85079	



TTS – Lindy bin with White swing lid

SKU:	Size:
NG 12040059-05	25L
NHSSC MMB85075	



Have a question? Call on 01726 813979 or email us at hello@ninegrp.com – we’re happy to help!

TTS Lindy Bin with Swing Lid 50L

50L with coloured swing lid waste collection bin.

Ideal for any environments. Colour coded lids ideal for separate waste collection. We recommend 60x65cm garbage bags for Lindy Swing coloured 50L.



Features:

- Handy: the swing opening of the lid can be locked to facilitate waste disposal
- Easy to maintain: the smooth surfaces and the absence of cavities facilitate cleaning and guarantee a high level of hygiene



TTS - Lindy bin with Red swing lid 50L

SKU:	Size:
NG 12040061-01 NHSSC MMB85090	50L



TTS - Lindy bin with Blue swing lid 50L

SKU:	Size:
NG 12040061-02 NHSSC MMB85070	50L



TTS - Lindy bin with Green swing lid 50L

SKU:	Size:
NG 12040061-03 NHSSC MMB85068	50L



TTS - Lindy bin with Yellow swing lid 50L

SKU:	Size:
NG 12040061-04 NHSSC MMB85087	50L



TTS - Lindy bin with White swing lid 50L

SKU:	Size:
NG 12040061-05 NHSSC MMB85080	50L



TTS - Lindy bin with Grey swing lid 50L

SKU:	Size:
NG 12040061-11 NHSSC MMB85069	50L

TTS Max Bin with Swing Lid 12L

12L with coloured swing lid waste collection bin.
 Ideal for any environments. Colour coded lids ideal for separate waste collection. We recommend 50x60cm standard garbage bags.

- Features:**
- Ideal to create zones of separate waste collection thanks to the colour-coded lids
 - Discrete: the swing lid avoids seeing the content of the bin
 - Easy to maintain: the smooth surfaces and the absence of cavities facilitate cleaning and guarantee a high level of hygiene



TTS – Max bin with Red swing lid

SKU:	Size:
NG 12040058-01	12L
NHSSC MMB85064	



TTS – Max bin with Blue swing lid

SKU:	Size:
NG 12040058-02	12L
NHSSC MMB85072	



TTS – Max bin with Green swing lid

SKU:	Size:
NG 12040058-03	12L
NHSSC MMB85077	



TTS – Max bin with Yellow swing lid

SKU:	Size:
NG 12040058-04	12L
NHSSC MMB85084	



TTS – Max bin with White swing lid

SKU:	Size:
NG 12040058-05	12L
NHSSC MMB85078	

TTS Moji Bin with Pedal Operated Lid 50L

Bin with pedal and lid, with odour eliminating cartridge box and bag tightener. Waste collection bin ideal for any environments. We recommend 60x65cm garbage bags. In compliance with the H.A.C.C.P. regulation, that require bins avoiding any contact with the hands and are easy to clean and disinfect.



TTS - Moji bin White with pedal operated lid 50L

SKU:		Size:	
NG	12040056-05		50L
NHSSC	MMB85065		

Features:

- Hygienic: thanks to the pedal, it can be used without any hand contact
- Handy: slits allow the waste collection bag to be fixed
- Easy to maintain: the smooth surfaces and the absence of cavities facilitate cleaning and guarantee a high level of hygiene
- Customisable: the lid can be customised graphically to make the dustbin a means of communication



Ask us about our all-in-one high level disinfectant range

- Comes ready to use, no mixing, no diluting, reducing human error
- Effective against, Spores, Viruses, Bacteria & Fungi
- One solution keeping it simple & easy

See pages 113 to 125

TTS Open-Up Front Opening Bin with pedal Operated Lid

Bin with pedal with front door, lid with odour eliminating cartridge box, Shhut System and 125 mm wheels. Bin with door for an ergonomic emptying of waste, Ideal for any environments. Eco-friendly: completely made of polypropylene, non-rusting, solid and entirely recyclable. Colour coded lids ideal for separate waste collection. We recommend 80x110cm standard garbage bags in the 90L version and 70x110cm standard bags in the version with 2x45L insert

Features:

- Ergonomic: the front door allows bag extraction without the need to lift it
- Handy: provided with wheels and ergonomic handle
- Discrete: the soft closing lid assures a noiseless moving
- Easy to maintain: the smooth surfaces and the absence of cavities facilitate cleaning and guarantee a high level of hygiene
- Anti-odour: lid provided with odour eliminating cartridge box
- Efficient: version with 2x45L insert to set up practical departments, in which different types of waste can be disposed of, encouraging its recycling



TTS Open-Up Front Opening Bin with pedal Operated Lid - Red - 90 Litre

SKU:	Size:
NG 12040062-01 NHSSC MMB85121	90L



TTS Open-Up Front Opening Bin with pedal Operated Lid - Blue - 90 Litre

SKU:	Size:
NG 12040062-02 NHSSC MMB85117	90L



TTS Open-Up Front Opening Bin with pedal Operated Lid - Green - 90 Litre

SKU:	Size:
NG 12040062-03 NHSSC MMB85118	90L



TTS Open-Up Front Opening Bin with pedal Operated Lid - Yellow - 90 Litre

SKU:	Size:
NG 12040062-04 NHSSC MMB85119	90L



TTS Open-Up Front Opening Bin with pedal Operated Lid - White - 90 Litre

SKU:	Size:
NG 12040062-05 NHSSC MMB85122	90L



Spare Part / Accessory

Insert For Two Waste Streams - 2 x 45L

SKU:
NG 12040063 NHSSC MMB85120



Food Waste Caddy - 7L

New food waste caddies designed for kitchen. Food waste caddies that offer a practical solution to food waste recycling, keeping contents secure.



Food Waste Caddy - 7L

SKU:	Size:
NG 12040050-03 NHSSC	7L

Features:

- Lockable handle to help prevent spillages and access by pests.
- Wide aperture for the easy filling of food waste.
- Easy clean and dishwasher proof.
- Reinforced design and strengthened impact columns.
- Made in the UK from 100% recycled plastic and recyclable at end of life.

Polypropylene Pedal Bin - 50L [MRI Safe - Clinical Waste - Yellow]

Hands-free polypropylene pedal bins for the safe disposal of everyday waste. Sturdy foot operated bins made from easy-clean hygienic polypropylene, suitable for almost any environment.



Polypropylene Pedal Bin - 50L - MRI Safe - Clinical Waste - Yellow

SKU:	Size:
NG 13040060 NHSSC	50L

Features:

- Foot-pedal operation for the safe disposal of waste.
- Hands-free compliant with HACCP recommendations.
- Easy-clean polypropylene.
- Strong, sturdy design with reinforced edges for added strength.

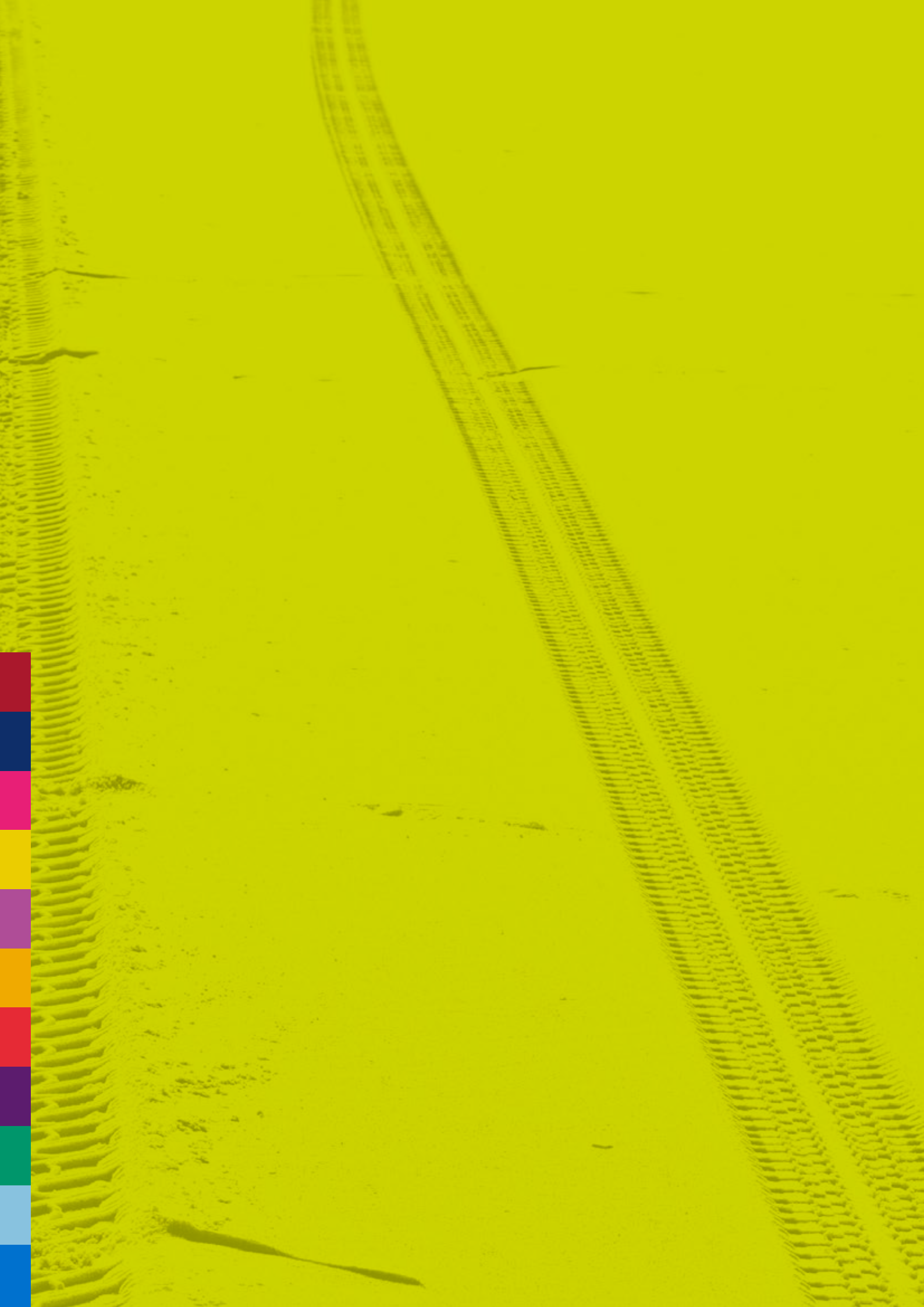

Vehicle

AdBlue® Diesel Exhaust Fluid

AdBlue is a high purity chemically produced carbamide solution dissolved in a high purity de-ionised water. AdBlue is a consumable for diesel-engined vehicles worldwide, and is injected into the SCR catalyst to break down soot and unburnt fuel into water and nitrogen. Both elements are harmless once they exit the exhaust system of the vehicles that generated them. The liquid is 32.5% urea and 67.5 deionized water.



AdBlue® Diesel Exhaust Fluid 10L

SKU:		Size:
NG	11170210-10	10L
NHSSC		

Uni9 Fast & Effective Traffic Film Remover

Uni9's Traffic Film Remover is a commercial grade traffic film remover, powerful enough to remove the most stubborn of dirt without damaging paintwork and decals. No wax additives mean that the glass screens remain clear and non-reflective, inbuilt polymers provide an extra sheen to the vehicle finish. Readily biodegradable the Uni9 TFR will leave your vehicle clean, shiny and streak free.



Features:

- Powerful Cleaning
- Water Rinsable
- Biodegradable



Uni9 Traffic Film Remover 20L

SKU:		Size:
NG	19170201-20	20L
NHSSC		



Uni9 Traffic Film Remover 5L

SKU:		Size:
NG	UN932001-5	5L
NHSSC		



Simpler Recycling Solutions

The UK government has introduced the 'Simpler Recycling' waste reforms to streamline recycling for households and businesses in England.

This initiative aims to create a more consistent recycling system, ensuring that people can recycle the same materials at home and in the workplace. By standardising waste collections, the scheme seeks to reduce confusion about what can be recycled, ultimately improving recycling rates and benefiting the environment.

Impact on you

Under the Simpler Recycling scheme, businesses, schools, hospitals, and other non-household municipal premises in England must separate dry recycling. Such as paper, card, plastic packaging, glass, and metal—from general waste for collection. Additionally, any business that produces food waste, regardless of the quantity, must also separate it for collection.

Sizes

Range of 15 to 50 litre systems specifically designed to make waste separation easier and more effective.

Coloured lids

Colour-coded bins are ideal for creating dedicated waste collection areas: the coloured lids make it possible to differentiate between different types of waste, facilitating collection. White, red, blue, green, yellow and brown: combine the colour options to differentiate waste collection, creating efficient and always neat areas.

Inserts

2 or 3 compartment configurations: whatever the need, inserts increase the collection possibilities by giving each waste stream the right location. Easy to apply, remove and clean, they make it possible to create practical separation in which different types of waste can be collected, promoting recycling.

See pages 201 to 211

Uni9 Fast & Effective Floor & Hard Surface Cleaner

Uni9’s Floor & Hard Surface Cleaner has a wide range of cleaning qualities, meaning that it can be used on a wide range of hard surfaces to give an excellent finish from either buffing or mopping.

Uni9’s Floor & Hard Surface Cleaner completes a number of tasks with one process, it will clean, deodorise and kill bacteria in one application. It has been produced fragrance-free or with a pleasant lemon aroma to complement the finished area. With a dilution rate of 1:15, Uni9’s Floor & Hard Surface Cleaner is not only an efficient hard surface cleaner but also a cost effective solution for all hard surface cleaning applications. Suitable for auto dosing systems.

- Features:**
- Antibacterial properties
 - Cleans, disinfects and deodorises in one application
 - Water rinsable
 - Chlorine free



Uni9 Hard Surface Floor Cleaner Concentrate - Lemon 20L

SKU:		Size:
NG	19041017	20L
NHSSC		



Uni9 Hard Surface Floor Cleaner Concentrate - Lemon 5L

SKU:		Size:
NG	19041015	5L
NHSSC	MKM85035	



Uni9 Hard Surface Floor Cleaner Concentrate - Lemon 1L in Dosing Bottle

SKU:		Size:
NG	19041013	1L (Auto Dose Bottle)
NHSSC	MKM85037	



Uni9 Floor/Hard Surface Cleaner Labelled Heavy Duty Trigger Spray Bottle - Yellow Trigger [Empty]

SKU:		Size:
NG	12040644-04	750ml
NHSSC	MKJ85790	

Uni9 Fast & Effective All Season Screen Wash

Uni9's Universal 'All Season' Screen Wash Cleaner has been manufactured for high use commercial applications. It is designed to be anti-smear and is the preferred choice for many motorists.

Suitable for use all year-round, dilute 1:5 and the antifreeze ingredient will keep the screen wash effective to -5, for harsh winter conditions, use neat in areas, locations where temperatures are expected to reach -15. Formulated to effectively remove insect smear, salt and road film. Does not damage wiper blades, rubber seals and does not cause light reflection.

Features:

- Anti-Smear
- Powerful Cleaning
- Fragranced
- Biodegradable



Uni9 All Season Screen Wash 20L

SKU:		Size:
NG	19041090-20	20L
NHSSC		



Uni9 All Season Screen Wash 5L

SKU:		Size:
NG	19041090-05	5L
NHSSC		



Accessories

Contents

1. **P-Wave®**

221 >

2. **TTS**

222 >

3. **Spray Bottles**

231 >

4. **Drum Pumps**

232 >

5. **Kitchen & Laundry
Essentials**

232 >

6. **Steps Stools**

233 >

7. **Sanitary**

233 >

8. **Wall Tidy**

233 >

P-Wave® Aromatic Air Fresheners

For full details- See pages 128 to 132



P-Wave® NHS (Cancer Symptom Message) Slant6 Deodorant Biodegradable Urinal Screen - Made from recycled material - Cotton Blossom - Pack of 10

SKU:

NG **11041420-15**
NHSSC **MKO85624**



P-Wave® Eco Air Freshener Air - 100% Recyclable - Cotton Blossom - Pack of 6

SKU:

NG **11041430-15**
NHSSC **MKJ85796**

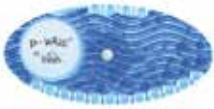

P-Wave® Curve Air Freshener - 100% Recyclable - Cotton Blossom - Pack of 10

SKU:

NG **11041425-15**
NHSSC **MKJ85786**



P-Wave® Easy Fresh Air Freshener Fragrance Cover - Cotton Blossom - Pack of 12

SKU:

NG **11041435-15**
NHSSC **MKJ85798**



P-Wave® MyFresh Air Freshener Fragrance Refill - 100% Recyclable - Alpine Forest - Pack of 6

SKU:

NG **11041440-21**
NHSSC **MKJ85782**



P-Wave® Bowl Clip Air Freshener - Cotton Blossom - Pack of 12

SKU:

NG **11041422-15**
NHSSC **MKJ85792**



P-Wave® Eco Air Freshener Dispenser Cabinet - No aerosols, no batteries, No propellants or solvents required - White

SKU:

NG **11041428**
NHSSC **MKJ85789**



P-Wave® Curve Holder - Pack of 30

SKU:

NG **11041426**
NHSSC **MKJ85780**



P-Wave® Easy Fresh Air Freshener Dispenser

SKU:

NG **11041434**
NHSSC **MKJ85795**



P-Wave® MyFresh Air Freshener Dispenser

SKU:

NG **11041438**
NHSSC **MKJ85797**

ACCESSORIES

222 | ninegrp.com

TTS Magic Line Trolley Hook for inserts



1x Green

SKU:

NG **12040472**
NHSSC **MKO85232**

TTS Magic Line Trolley Handle Holder



1x Green

SKU:

NG **12040471**
NHSSC **MKO85244**

TTS Magic Line Trolley 120L Lid for Bagholder with Checklist Holder



Red 120L Lid for bagholder
with checklist holder [MLT]

SKU:

NG **12040481-01**
NHSSC **MKO85183**



Blue 120L Lid for bagholder
with checklist holder [MLT]

SKU:

NG **12040481-02**
NHSSC **MKO85174**



Green 120L Lid for bagholder
with checklist holder [MLT]

SKU:

NG **12040481-03**
NHSSC **MKO85175**



Yellow 120L Lid for bagholder
with checklist holder [MLT]

SKU:

NG **12040481-04**
NHSSC **MKO85202**

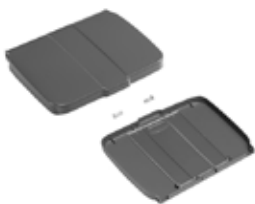

Grey 120L Lid for bagholder
with checklist holder [MLT]

SKU:

NG **12040481-11**
NHSSC **MKO85197**

TTS Magic Line Trolley 120L Plastified Bag with String



Red 120L Plastified Bag
with String

SKU:

NG **12040486-01**
NHSSC **MKO85184**



Blue 120L Plastified Bag
with String

SKU:

NG **12040486-02**
NHSSC **MKO85203**



Green 120L Plastified Bag with String

SKU:

NG **12040486-03**
NHSSC **MKO85219**



Grey 120L Plastified Bag with String

SKU:

NG **12040486-11**
NHSSC **MKO85155**



Yellow 120L Plastified Bag with String

SKU:

NG **12040486-04**
NHSSC **MKO85239**

TTS Magic Line Trolley 150L Lid for Bagholder with Checklist Holder



Red 150L Lid for bagholder with checklist holder [MLT]

SKU:

NG **12040482-01**
NHSSC **MKO85177**



Blue 150L Lid for bagholder with checklist holder [MLT]

SKU:

NG **12040482-02**
NHSSC **MKO85243**

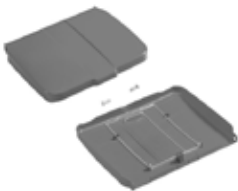

Grey 150L Lid for bagholder with checklist holder [MLT]

SKU:

NG **12040482-11**
NHSSC **MKO85162**



Yellow 150L Lid for bagholder with checklist holder [MLT]

SKU:

NG **12040482-04**
NHSSC **MKO85163**

TTS Magic Line Trolley 150L Plastified Bag with String



Red 150L Plastified Bag with String

SKU:

NG **12040487-01**
NHSSC **MKO85229**



Blue 150L Plastified Bag with String

SKU:

NG **12040487-02**
NHSSC **MKO85198**



Yellow 150L Plastified Bag with String

SKU:

NG **12040487-04**
NHSSC **MKO85213**



Grey 150L Plastified Bag with String

SKU:

NG **12040487-11**
NHSSC **MKO85212**

ACCESSORIES

224 | ninegrp.com

TTS Magic Line Trolley Magic Drawer [No key & Grey]



10L
SKU: _____
NG **12040461-10**
NHSSC **MKO85209**



22L
SKU: _____
NG **12040461-22**
NHSSC **MKO85176**



40L
SKU: _____
NG **12040461-40**
NHSSC **MKO85217**

TTS Magic Line Trolley Dividers



Single divider for
150 Litre bagholder
SKU: _____
NG **12040477**
NHSSC **MKO85178**



Double divider for 120 Litre
bagholder, 90L + 30L
SKU: _____
NG **12040475**
NHSSC **MKO85245**



Double divider for
120 Litre bagholder, 2x 70L
SKU: _____
NG **12040474**
NHSSC **MKO85188**



Triple divider for
120 Litre bagholder, 3x 40L
SKU: _____
NG **12040476**
NHSSC **MKO85180**

TTS Magic Line Trolley Grey Bag Clip



120L
SKU: _____
NG **12040478**
NHSSC **MKO85204**



150L
SKU: _____
NG **12040479**
NHSSC **MKO85161**

TTS Trolley Support For Carpet Sweeper / Steps



SKU:
 NG **12040599**
 NHSSC **MGJ85019**

TTS Magic Line Trolley Shelves Set [Basic]



Grey
 SKU:
 NG **12040462**
 NHSSC **MKO85228**

TTS Magic Line Trolley Bag Holding Plate



Grey
 SKU:
 NG **12040466**
 NHSSC **MKO85169**

TTS Magic Line Trolley Security key



Grey
 SKU:
 NG **12040467**
 NHSSC **MKO85187**

TTS Magic Line Trolley Hermetic Bucket Base



Grey
 SKU:
 NG **12040465**
 NHSSC **MKO85207**

TTS Magic Line Trolley Bar Replacement Floor Sign Support



Only S530472 with x2 pins S530473 [Bar Replacement Floor Sign Support]
 SKU:
 NG **12040470**
 NHSSC **MKO85231**

TTS Magic Line Trolley Shelf [Reinforced]



Grey
 SKU:
 NG **12040463**
 NHSSC **MKO85168**

TTS Lateral Basin Grey [To carry hermetic buckets on the front of the trolley]



Grey
 SKU:
 NG **12040464**
 NHSSC **MKO85186**

ACCESSORIES

226 | ninegrp.com

TTS Magic Line Trolley Holder to fit Scout



Green / Insert

SKU:

NG **12040473**
NHSSC **MKO85215**

TTS Magic Line Trolley Door Handle [Cabinet]



Grey

SKU:

NG **12040469**
NHSSC **MKO85156**

TTS Hermetic Lid [Grey]



TTS - Hermetic Lid Grey,
with Hermetic Seal

SKU:

NG **12040533**
NHSSC **MKO85224**

TTS Hermetic Grid [for use with Hermetic Buckets]



Grey

SKU:

NG **12040534**
NHSSC **MKO85236**

TTS Magic Line Trolley Covering Cap



Grey / Insert

SKU:

NG **12040468**
NHSSC **MKO85230**

TTS SHHUT System, x2 pcs for quiet / Soft close lid operation, Grey



Grey

SKU:

NG **12040480**
NHSSC **MKO85172**

TTS Tec Wringer [Green]



TTS - Tec wringer, Green

SKU:

NG **12040522**
NHSSC **MKO85160**

TTS Scout handle holder



Grey / Insert

SKU:

NG **12040452**
NHSSC **MKO85220**

TTS Frame Pocket System



BLIK Lampo - Block
40cm, inc Jack Lampo
for ø 23 mm handles

SKU:

NG **12040409-40**
NHSSC **MKB85574**

TTS Magic Line Trolley Shelves Set [Basic]



BLIK, 40cm for ø 23
mm handles

SKU:

NG **12040410**
NHSSC **MKB85288**

TTS Frame Pockety



40cm, inc Jack Lampo
for ø 23 mm handles

SKU:

NG **12040417**
NHSSC



40cm, Block System
Joint for ø 23 mm
handles

SKU:

NG **12040416**
NHSSC

TTS Frame Uni Junior System



30cm, Flat Mop Frame

SKU:

NG **12040415**
NHSSC **MKB85244**



40cm, Flat Mop Frame

SKU:

NG **12040411**
NHSSC **MKB85259**

TTS Frame Lamello

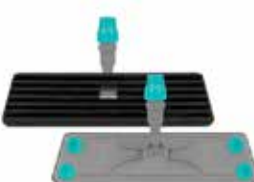

40cm with disposable
dusting cloth

SKU:

NG **12040420-40**
NHSSC **MKB85285**

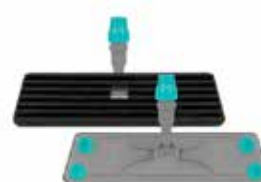

60cm with disposable
dusting cloth

SKU:

NG **12040420-60**
NHSSC **MKB85288**

ACCESSORIES

228 | ninegrp.com

TTS Frame **Lamello Lampo with Block**



40cm for use with
disposable dusting cloth

SKU:

NG **12040421-40**
NHSSC **MKO85628**



60cm for use with
disposable dusting cloth

SKU:

NG **12040421-60**
NHSSC **MKO85625**

TTS Frame **Trilogy**



40cm

SKU:

NG **12040412**
NHSSC **MKB85272**

TTS Frame **Velook**

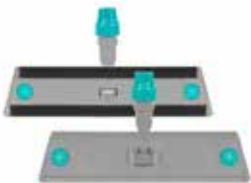

40cm for use with Velook
and velcro Type Mops

SKU:

NG **12040413**
NHSSC **MKB85248**

TTS Frame **Clean Glass** **Velook Mini with Wall Lock**



with Wall Lock - Grey

SKU:

NG **12040302**
NHSSC **MKO85238**

TTS **Lampo Jack**



For \varnothing 23mm handles -
Threaded cone with clip
for connecting Lampo
compatible tools to handles

SKU:

NG **12040486**
NHSSC **MKO85210**

TTS Lampo Plug



TTS Lampo Plug For Magic Panel

SKU:

NG **12040288**
NHSSC **MKD85823**

TTS Lampo Plug For Magic Frame - Left

SKU:

NG **12040289-02**
NHSSC **MKD85816**

TTS Lampo Plug For Magic Frame - Right

SKU:

NG **12040289-01**
NHSSC **MKD85822**

TTS OPEN-UP Front Opening Bin



Insert For Two Waste Streams - 2 x 45L

SKU:

NG **12040063**
NHSSC **MMB85120**

TTS Pockety



Wheeled 20L Rectangular Bucket Structure

SKU:

NG **12040595-02**
NHSSC

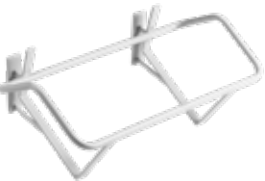

Wheelless 20L Rectangular Bucket Structure

SKU:

NG **12040595-01**
NHSSC



Pockety lid

SKU:

NG **12040539**
NHSSC



Red 35L Collection Bag with String

SKU:

NG **12040678-01**
NHSSC



Blue 35L Collection Bag with String

SKU:

NG **12040678-02**
NHSSC

ACCESSORIES

230 | ninegrp.com

TTS BIO



TTS BIO System Bottle -
0.65L - Red

SKU:

NG **12040373-01**
NHSSC **MKB85569**



TTS BIO System Bottle -
0.65L - Blue

SKU:

NG **12040373-02**
NHSSC **MKB85564**



TTS BIO System Bottle -
0.65L - Green

SKU:

NG **12040373-03**
NHSSC **MKB85568**



TTS BIO System Bottle -
0.65L - Yellow

SKU:

NG **12040373-04**
NHSSC **MKB85571**



TTS BIO System Bottle -
0.65L - Grey

SKU:

NG **12040373-11**
NHSSC **MKB85575**



TTS BIO Non Slip
Cap - Red

SKU:

NG **12040372-01**
NHSSC **MKB85573**



TTS BIO Non Slip
Cap - Blue

SKU:

NG **12040372-02**
NHSSC **MKB85566**



TTS BIO Non Slip
Cap - Green

SKU:

NG **12040372-03**
NHSSC **MKB85565**



TTS BIO Non Slip
Cap - Yellow

SKU:

NG **12040372-04**
NHSSC **MKB85572**



TTS BIO Non Slip
Cap - Grey

SKU:

NG **12040372-11**
NHSSC **MKB85570**

Heavy Duty Labelled Trigger Spray Bottle [Empty]



Uni9 Multipurpose Cleaner Labelled Heavy Duty Trigger Spray Bottle - Red Trigger [Empty]

SKU:

NG **12040644-01**
NHSSC **MKJ85788**



Medi9 RTU Surface Sanitiser Labelled Heavy Duty Trigger Spray Bottle - Blue Trigger [Empty]

SKU:

NG **12040644-02**
NHSSC **MKO85626**



Uni9 Floor/Hard Surface Cleaner Labelled Heavy Duty Trigger Spray Bottle - Yellow Trigger [Empty]

SKU:

NG **12040644-04**
NHSSC **MKJ85790**

Spray Head & Bottle Set 750ml - Heavy Duty [Empty]



Spray Head & Bottle Set - 750ml - Heavy Duty - Red [Empty]

SKU:

NG **12040642-01**
NHSSC **MMW85014**



Spray Head & Bottle Set - 750ml - Heavy Duty - Blue [Empty]

SKU:

NG **12040642-02**
NHSSC **MMW85011**



Spray Head & Bottle Set - 750ml - Heavy Duty - Green [Empty]

SKU:

NG **12040642-03**
NHSSC **MMW85012**



Spray Head & Bottle Set - 750ml - Heavy Duty - Yellow [Empty]

SKU:

NG **12040642-04**
NHSSC **MMW85013**



Spray Head & Bottle Set - 750ml - Heavy Duty - White [Empty]

SKU:

NG **12040642-05**
NHSSC **MMW85015**

ACCESSORIES

232 | ninegrp.com

Drum Pump



30ml - 38mm Closure
For 5L Bottles

SKU:

NG **A20210**
NHSSC



30ml - 60mm Closure
for 20/25L Bottles

SKU:

NG **A20214**
NHSSC

Magic Erase-All Sponge



Pack of 10

SKU:

NG **11040510**
NHSSC **MK085218**

Washing Up Bowl



Single 9L

SKU:

NG **12040622**
NHSSC **MK085153**

Caterers Sponge Scourer

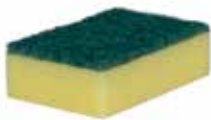

Pack of 10

SKU:

NG **HY923081-CS**
NHSSC

Caterers Scourers - Standard



Green, Pack of 10

SKU:

NG **HY923080-SDG**
NHSSC

Caterers Scourers - Heavy Duty



Green, Pack of 10

SKU:

NG **HY923080-HDG**
NHSSC

Plastic Step Stool



Grey 1x

SKU:

NG **EQ910101**
NHSSC

Sanitary Bag Dispenser



1x

SKU:

NG **HY922951**
NHSSC

Sanitary Bag Refill



Pack of 25

SKU:

NG **HY922952**
NHSSC

Wall Tidy - Hangs Three Handles



Wall Tidy - Red - Hangs
Three Handles

SKU:

NG **12040269-01**
NHSSC



Wall Tidy - Blue - Hangs
Three Handles

SKU:

NG **12040269-02**
NHSSC



Wall Tidy - Green - Hangs
Three Handles

SKU:

NG **12040269-03**
NHSSC



Wall Tidy - Yellow - Hangs
Three Handles

SKU:

NG **12040269-04**
NHSSC



Wall Tidy - White - Hangs
Three Handles

SKU:

NG **12040269-05**
NHSSC





Keeping you safe.

The ultimate
alcohol free
disinfectant
with Medi9.

**If you have any questions or
require assistance, please
don't hesitate to contact us.
We're here to help.**

01726 813979
hello@ninegrp.com

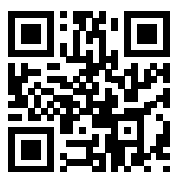

06.2025



ninegrp.com

Nine Group

Freedom House, Par Moor Rd,
Par PL24 2SQ United Kingdom

